

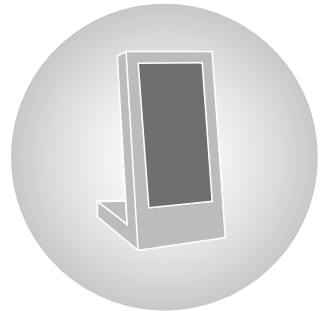

SALES PROMOTION

Targeted sales increase for customers and incentives to buy at the point of sale

OVERVIEW OECHSLE PORTFOLIO

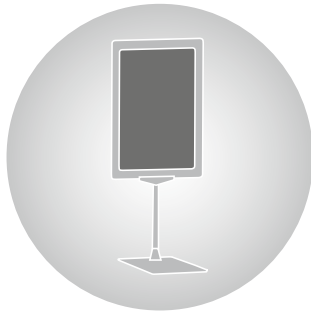

SHELF MANAGEMENT

Shelf dividers

PRIMA +S
Standard
PRIMA +T
Prima 2.0
Accessories

Product pushers

Product pusher with spring
Product feed with gravity system
Product feeds for freezer shelves
Manual product pusher

Profile rails

Scanner rails

SALES PROMOTION

Poster frames

Plastic frames
Shelf lighting
Wooden frames
LED frames
Poster holders
Accessories

Hanging Systems

Acryl displays and stands

Shelf stoppers and wobblers

PRICE LABELLING

KLICK system

Scanner rails

ESL holders

Price tags

DIGITAL SIGNAGE

Digital a-boards

Digital totems

Digital displays



Poster frames	5
Hanging systems	59
Acrylic displays and stands	73
Checkout equipment	79
Shelf stoppers and wobblers	87

MORE ABOUT OECHSLE PRODUCTS

We provide you with brochures for some selected products. They contain detailed information and numerous illustrated examples of usage.

Ask us for your printed catalogue or use the digital edition on our website: www.oechsle.de

We offer product brochures for:

- PRIMA 2.0
- Heavy Duty Tray (HDT)
- Metal Tray
- Gliding systems
- Roller track XL
- LED lighting



WHO WE ARE

Whether you are looking for shelf management systems, product and price labelling, LED shelf lighting or poster frames – as a specialist in sales promotion, Oechsle offers you a broad spectrum of PoS material.

Since 1956 we have been a successful medium-size family-owned business and partner, a supplier of national and international trade. Thanks to our in-house mould construction, injection moulding and aluminium processing, we not only offer standard products – you can also order individual solutions for your projects.



POINT OF SALE EXPERT

As a global distributor, we benefit from more than 60 years of experience around the PoS. Our competences are shelf management, product and price labelling, sales promotion and digital signage.

The range of our customers extends from the industries food retail, drug stores to brand manufacturers, speciality trade and DIY stores up to tobacconists, petrol stations and shopfitters.

FACTS AND FIGURES OF OECHSLE

With 36 injection moulding machines in total we produce more than 3,000 standard products, which can be retrieved at any time from our 2,500 sqm warehouse.

Our technicians in the construction department develop the injection moulds themselves, so they can be manufactured in our in-house mould-making. The full-service offering is complemented by our aluminium processing and LED assembly whereby we are able to fulfil all standard requirements as well as individual requests.

We can respond quickly and flexible to customers requests, since shipping and logistics are processed within the company. werba print & display also provide support as a strong partner at Oechsle's side. Together, we form an unbeatable duo for point of sale display and PoS material.



Further information and details are available at www.oechsle.de



POSTER FRAMES

Presenting your range in the right poster frame

PLASTIC FRAMES

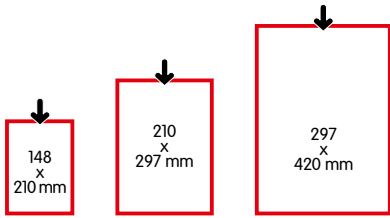

DEKOLINE

Classic showcard frame with pointed corners. Short side poster entry, max. poster insert thickness up to 4,5 mm.

- 11520-xx DIN A5
- 11420-xx DIN A4
- 11330-xx DIN A3

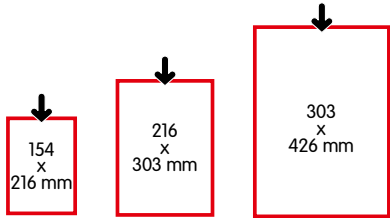
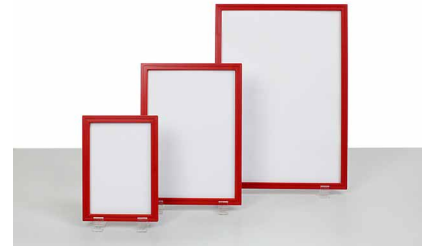

LAMINATE

Showcard frame especially designed for laminated posters that do not fit into standard frames in DIN sizes. Short side poster entry, max. poster thickness 4,5 mm.

- 11508-xx DIN A5 plus
- 11408-xx DIN A4 plus
- 11308-xx DIN A3 plus

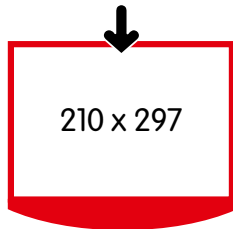
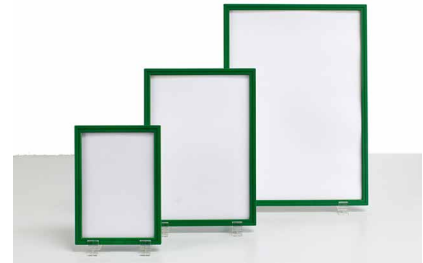

TWINSET BASIC FRAME DIN A4 LANDSCAPE

To hold tubes ø 10 mm at the bottom. Long side poster entry, max. insert thickness 3 mm. Color: anthracite.

18060-7016

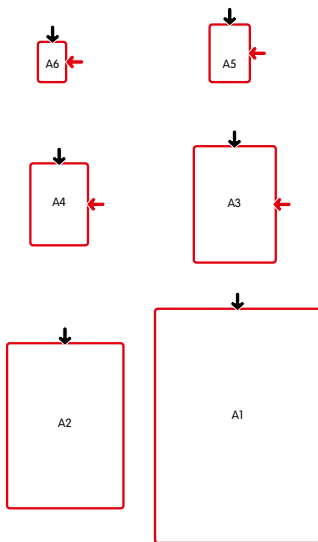

STANDARD

Classic showcard frame, solid and extremely stable profile made of plastic. DIN A6 - DIN A3 = accessories series 100, max. poster insert thickness of up to 3 mm. DIN A2 - DIN A1 = accessories series 200, max. poster insert thickness of up to 4 mm. Colors: Standard and additional colors (LSE only additional colors).

- 11600-xx DIN A6
- 11601-xx DIN A6 - LSE
- 11500-xx DIN A5
- 11501-xx DIN A5 - LSE
- 11400-xx DIN A4
- 11401-xx DIN A4 - LSE
- 11300-xx DIN A3
- 11301-xx DIN A3 - LSE
- 12200-xx DIN A2
- 12100-xx DIN A1



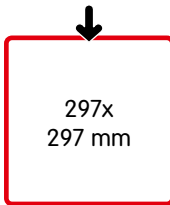

SHOWCARD FRAME 297 X 297 MM

Showcard frame in special size 297 x 297 mm.

11840-xx



SHOWCARD FRAME 140 X 417 MM

Showcard frame in special size 140 x 417 mm.

11855-xx

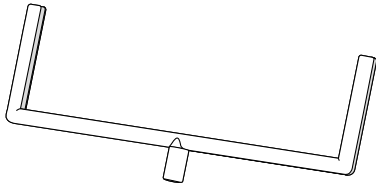

U-FRAME DIN A4 LANDSCAPE

To hold tubes ø 10 mm, to be used with acrylic cover or posters made of thick and stable carton with max. up to 5 mm thickness. Colors: white, grey, red.

20090-xx



GREENLINE

Showcard frame with pointed corners made of organic plastic. Short side poster entry. Colors: natural, organic green.

- 11330-G-xx DIN A3
- 11420-G-xx DIN A4
- 11520-G-xx DIN A5



SHOWCARD FRAME FOR SHOPPING TROLLEYS - LSE

For fixing on shopping trolleys, made of plastic. Measurements: 252x195 mm. To be mounted on the inner or outer side with the fixing set (to be ordered separately).

11405-06

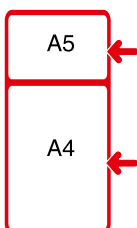

SHOWCARD FRAME CROSS BAR

To insert two posters (DIN A4 portrait and DIN A5 landscape), long side poster entry. Colors: white, green, red.

11445-xx

ALUMINIUM FRAMES

PVC PROTECTIVE COVERS

Suitable for showcard frames of same DIN size, non-reflective, transparent.

29000-A5/02	A5 (0,2 mm)
29000-A4/02	A4 (0,2 mm)
29000-A3/02	A3 (0,2 mm)
29010-A2/05	A2 (0,5 mm)
29010-A1/05	A1 (0,5 mm)
29010-A0/05	A0 (0,5 mm)
29010-B2/05	500 x 700 mm (0,5 mm)
29010-B1/05	700 x 1000 mm (0,5mm)

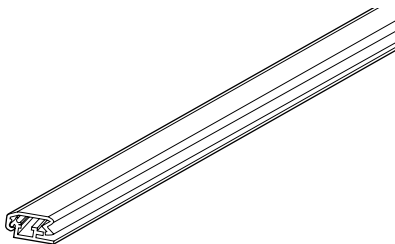
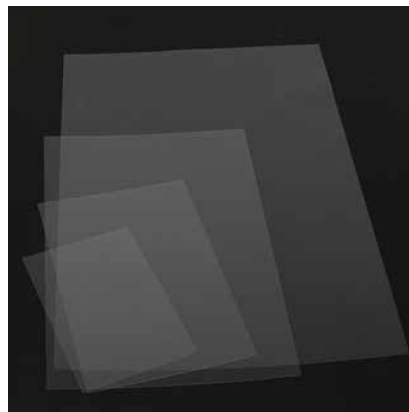

ALU SNAP-TYPE FRAME PROFILE 20 MM

Anodized aluminium snap-type frame, with mitred corners, grey plastic rear and non-reflective PVC cover.

51500-A5/91	A5
51500-A4/91	A4
51500-A3/91	A3

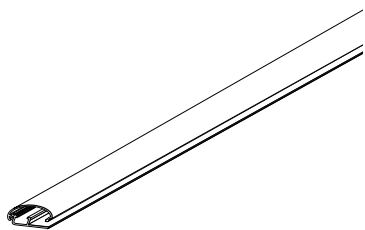

ALU SNAP-TYPE FRAME PROFILE 25 MM PREMIUM

Anodized aluminium snap-type frame, with mitred corners, grey plastic rear and non-reflective PVC cover.

51000-A4/91	A4
51000-A3/91	A3
51000-A2/91	A2
51000-A1/91	A1
51000-B2/91	500x700 mm



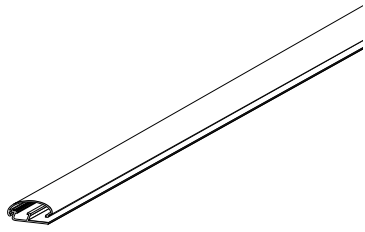

**ALU SNAP-TYPE FRAME PROFILE
25 MM ECO**

Anodized aluminium snap-type frame, with mitred corners, grey plastic rear and non-reflective PVC cover.

71-58405-00	A5
71-58404-00	A4
71-58403-00	A3
71-58402-00	A2
71-58401-00	A1

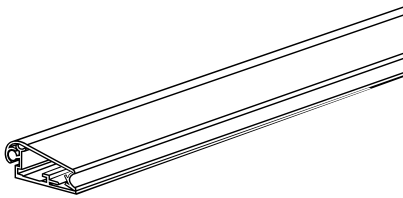

**ALU SNAP-TYPE FRAME PROFILE
32 MM CHROMIUM CORNERS PREMIUM**

Anodized aluminium snap-type frame, with chromium corners, grey plastic rear and non-reflective PVC cover.

51101-A3/91	A3
51101-A2/91	A2
51101-A1/91	A1
51101-A0/91	A0
51101-B1/91	700x1000 mm

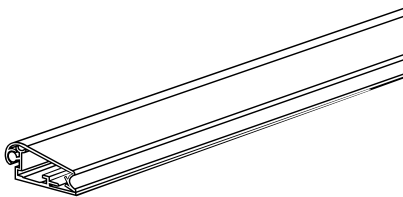

**ALU SNAP-TYPE FRAME PROFILE
32 MM MITRED CORNERS PREMIUM**

Anodized aluminium snap-type frame, with mitred corners, grey plastic rear and non-reflective PVC cover.

51100-A3/91	A3
51100-A2/91	A2
51100-A1/91	A1
51100-A0/91	A0
51100-B1/91	700x1000 mm



ALUMINIUM FRAMES

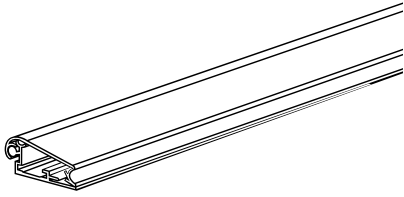

**ALU SNAP-TYPE FRAME PROFILE
32 MM CHROMIUM CORNERS ECO**
Anodized aluminium snap-type frame, with chromium corners, grey plastic rear and non-reflective PVC cover.

- 71-51502-00 A2
- 71-51501-00 A1

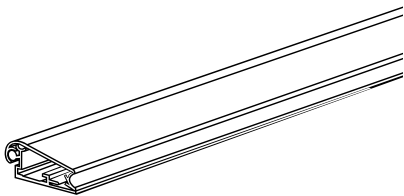

**ALU SNAP-TYPE FRAME PROFILE
32 MM MITRED CORNERS ECO**
Anodized aluminium snap-type frame, with mitred corners, grey plastic rear and non-reflective PVC cover.

- 71-51402-00 A2
- 71-51401-00 A1

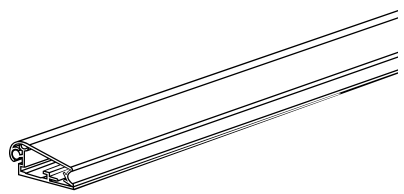

**ALU SNAP-TYPE FRAME PROFILE
32 MM WEATHER RESISTANT A1 PLUS**
Anodized aluminium snap-type frame, with mitred corners and zinc metal rear plate. With framed, slightly visible rubber sealing tape (poster lays inside the tape) and non-reflective PVC cover.

- 51130-A1/91



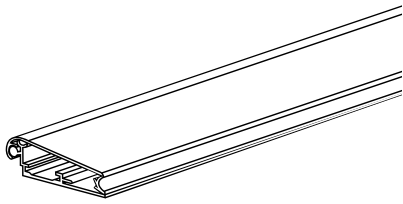

ALU SNAP-TYPE FRAME PROFILE 44 MM A0

Anodized aluminium snap-type frame, with mitred corners, grey plastic rear and non-reflective PVC cover.

51300-A0/91

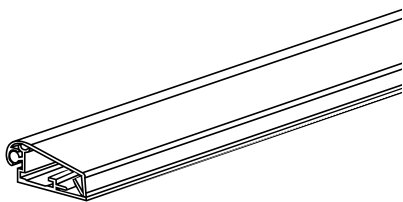
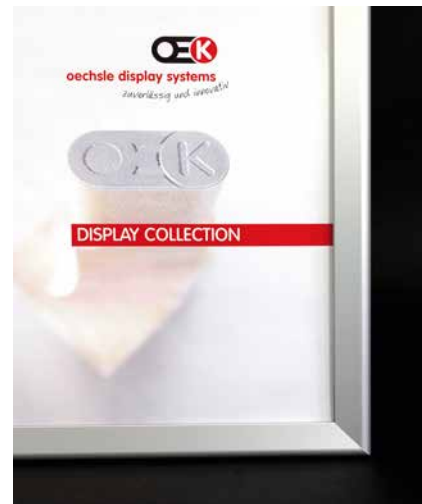

ALU SNAP-TYPE FRAME PROFILE 32 MM A1 WITH SECURITY PROFILE

Anodized aluminium snap-type frame, with mitred corners, grey plastic rear and non-reflective PVC cover. Profile opening only possible with special key (to be ordered separately).

51200-A1/91



KEY FOR SECURITY PROFILE

Suitable for alu snap-type frame profile 32 mm with security profile, black.

57110-10



PVC PROTECTIVE COVER DIN A1 PLUS

Suitable for showcard frames of same DIN size, non-reflective, transparent.

29010-0010/05

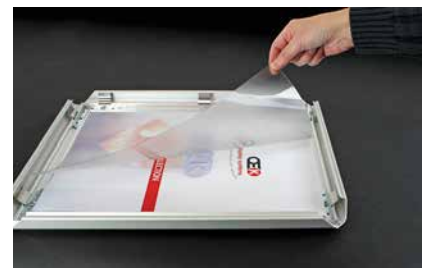

ALUMINIUM FRAMES

ALU SNAP-TYPE FRAME FOR WINDOWS

Anodized aluminium snap-type frame, with mitred corners, without rear. With double adhesive tape and non-reflective PVC cover. For special use on glass, in shopping windows, etc. Counterframe to be ordered separately.

- 51166-A2/91 A2 (profile 32 mm)
- 51166-A1/91 A1 (profile 32 mm)
- 51366-A0/91 A0 (profile 44 mm)



COUNTER FRAME

Anodized flat aluminium profile 30 mm, to cover the double adhesive tape on window of the snap-type frame on the opposite side. Frame not mounted.

- 51172-A2/91 A2
- 51172-A1/91 A1
- 51372-A0/91 A0



TENSILE FRAME A1

Anodized aluminium tubes Ø 9 mm, rounded plastic corners, grey with integrated suspension rings. Quick and easy poster change by means of clips. Delivery comes unmounted for self-assembly.

- 50301-91



ALU PROFILE FRAME

Stable, double-wall aluminium profile anodized. Poster insert on short frame side. Poster strength max. 4,5 mm.

58000-A4/91	A4
58000-A3/91	A3
58000-A2/91	A2
58000-A1/91	A1



ALU PROFILE U-FRAME

For category marking on metal shelves, for signs and boards with a material thickness up to 4,5 mm. Set incl. two magnets Ø 50 mm, magnetic force up to 18 kgs. Size: 700x120 mm.

58525-0001/91



TOPPER

Alu profile frame anodized landscape with poster insert on long frame side. Rubber sealing for insert profile, base profile with double-adhesive tape. Optional accessories: PVC protective covers and PS inserts.

58412-A4/91	A4
58412-A3/91	A3



SHOWCARD STAND LIBERTY WITH ALU PROFILE FRAME A2

BD base Ø 255 mm, silvergrey, fixed aluminium tube 1600 mm, aluminium profile frame A2 and fixing set with tube clamps.

63112-91/1600



ALUMINIUM FRAMES



ALU PAVEMENT SUPPORT PROFILE 25 MM ECO

Alu pavement support, with two snap-type frames A1, profile 25 mm, foldable with metal scissors, grey plastic rear. Stand profiles (30x15 mm) blank aluminium, incl. non-reflective PVC cover. Total height 1000 mm.

71-52006-A1/91 A1 (mitred corners)

71-52007-A1/91 A1 (chromium corners)



ALU PAVEMENT SUPPORT PROFILE 32 MM ECO

Alu pavement support, with two snap-type frames A1, profile 32 mm, foldable with metal scissors, grey plastic rear. Stand profiles (30x15 mm) blank aluminium, incl. non-reflective PVC cover. Total height 1050 mm.

71-52116-A1/91 A1 (mitred corners)

71-52117-A1/91 A1 (chromium corners)



ALU PAVEMENT SUPPORT PROFILE 32 MM PREMIUM

High quality manufactured alu pavement support, with two alu snap-type frames A1, profile 32 mm, foldable with plastic scissors, black, plastic rear, grey. Stand profiles (25x25 mm) blank aluminium, incl. non-reflective PVC poster protector. Total height: 1200 mm.

52100-A1/91 A1 (mitred corners)

52101-A1/91 A1 (chromium corners)





ALU PAVEMENT SUPPORT WEATHER-RESISTANT A1 PLUS

High quality manufactured alu pavement support, with two alu snap-type frames A1, profile 32 mm, with mitred corners, foldable with plastic scissors, black. With metal rear and slightly visible sealing rubber tape (poster lays inside the rubber tape). Stand profiles (25x25 mm) blank aluminium, incl. non-reflective PVC poster protector.

52130-A1/91



POSTER-VIP ECO A1

Stable outdoor stand with two alu snap-type frames A1, profile 40 mm (upper profile anodized or black), with mitred corners. With plastic corner protection caps, weather resistant with sealing rubber tape, 2 rollers and fillable base (grey or black) with 24 l volume. Empty weight 3,5 kgs. Total height 1180 mm.

54641-03/T anodized
54641-10/T black



POSTER-VIP W A1

Stable outdoor stand with two alu snap-type frames A1, profile 40 mm, with mitred corners. With plastic corner protection caps, weather resistant with sealing rubber tape, 2 rollers and fillable base, grey, with 42 l volume. Empty weight 10,5 kgs. Total height 1275 mm.

54651-00



SHOWCARD FRAME WOODLINE

Massive wooden frame made of natural beech. Poster insert on short frame side. Max. poster insert thickness up to 4 mm. For a direct tube connection also available with galvanized internal thread M10.

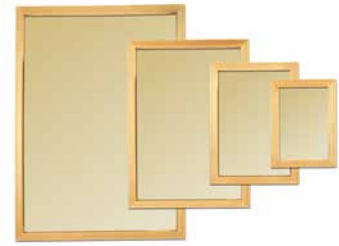

15350-00	DIN A5
15351-00	DIN A5 - M10
15340-00	DIN A4
15341-00	DIN A4 - M10
15330-00	DIN A3
15332-00	DIN A3 - M10
15320-00	DIN A2
15321-00	DIN A2 - M10
15310-00	DIN A1
15370-00	50x700 mm



WOODEN BASE FOR WOODLINE FRAMES (PAIR)

For an upright presentation of Woodline frames, made of massive natural beech, incl. screws for fixing.



25882-11	Small
25880-11	Large



WOODLINE FRAME

Massive wooden frame made of natural beech or thermo ash. Sawed on mitred. Poster entry short side. Max. poster insert thickness up to 4 mm. Backside with 4 holes for hanging portrait or landscape. Please note that accessories series 500 are not compatible to this product.



15380-00/A5	DIN A5 (natural beech)
15380-TE/A5	DIN A5 (thermo ash)
15380-00/A4	DIN A4 (natural beech)
15380-TE/A4	DIN A4 (thermo ash)
15380-00/A3	DIN A3 (natural beech)
15380-TE/A3	DIN A3 (thermo ash)

ALUMINIUM FRAMES

LEAFLET DISPENSER QP

Leaflet dispenser with 3, 4, 5 or 6 inclined dispensers A4 made from PET-G. (Arrangement of dispensers also possible in zig-zag form). With metal base 300x300 mm. Total height 1400 mm .

- 61015-00/1400/3 With 3 acrylic dispensers
- 61015-00/1400/4 With 4 acrylic dispensers
- 61015-00/1400/5 With 5 acrylic dispensers
- 61015-00/1400/6 With 6 acrylic dispensers



REPLACEMENT TRAY FOR LEAFLET DISPENSER QP

90-422206



LEAFLET DISPENSER PS 1

BD base Ø 255 mm black with fixed aluminium tube 800 mm, acrylic box A4, fixed with black hinge on box's rear to adjust inclined positions.

61504-10/800



WOODEN FRAMES



WOODEN BASE FOR WOODLINE FRAMES

Wooden stand to hold woodline frames. Base made of natural beech or thermo ash.

- 20495-00/A3 A3 (natural beech)
- 20495-TE/A3 A3 (thermo ash)
- 20495-00/A4 A4 (natural beech)
- 20495-TE/A4 A4 (thermo ash)
- 20495-00/A5 A5 (natural beech)
- 20495-TE/A5 A5 (thermo ash)



SHOWCARD STAND WOODLINE

Round wooden stepped base Ø 160 mm, fixed aluminium tube 320 mm, black, with threaded bolt M10. Woodline frame with internal thread (chalk board to be ordered separately.)

- 33384-10/320 A4
- 33383-10/320 A3



FLOOR SHOWCARD STAND WOODLINE

BD base Ø 255 mm, black, adjustable aluminium tube 1000-1900 mm, with locking screw and T-piece 550 mm, black and showcard frame Woodline.

- 33384-91/-1900/10 A4
- 33383-91/-1900/10 A3



WOODEN STEPPED BASE

Made of massive, natural beech wood, Ø 160 mm, height 20 mm. Suits anodized or powder coated aluminium tubes Ø 16 mm.

20491-00/A



TABLE STAND BIG CUBE

Wooden stand made of pure oak with chalk board A5 black. Size 60x60x48 mm.

20480-00



TABLE STAND ARCH 1/4

Wooden stand quarter circled made of pure oak with chalkboard. Measurements small 30x30x30 mm. Measurements large 60x60x30 mm.

20484-00 small (A7)

20483-00 large (A6)



TABLE STAND ARCH 1/2

Wooden stand semi-circled made of pure oak, to insert chalkboards, promotion cards, menu cards etc. Size: 120x60x30 mm. Chalkboard to be ordered separately.

20485-00



TABLE STAND RECTANGULAR

Wooden stand rectangular made of pure oak, to hold chalkboards, promotion cards, menu cards, etc. Size: 105x40x40 mm. Chalkboard to be ordered separately.

20482-00



WOODEN FRAMES

CHECKOUT DIVIDER WOOD

Made of pure oak. Size: 300x30x300 mm. Branding upon request.

- 37021-00 Rectangular
- 37020-00 Triangular



CHECKOUT DIVIDER T

Made of massive wood natural beech with continous T-profile slot and three supergrips to be inserted sideways, incl. PVC poster protector 297x140x0,5 mm.

37030-00



PAVEMENT SUPPORT WOODLINE OUTDOOR

Pavement support made of hornbeam oak with chalk boards both sides (area for writing 600x780 mm), black scissors and hinges. Height 1030 mm, weight approx. 6 kg.

18696-00



CHALK BOARD MARKER (WATER SOLUBLE)

To write on chalk boards, water soluble, white.

- 24281-01 Line width 2-6 mm
- 24280-01 Line width 15 mm



CHALK BOARD MARKER (WATER RESISTANT)

To write on chalk boards, water resistant, white.

- 24282-01 Line width 2-6 mm
- 24284-01 Line width 15 mm



POSTERMAN CLEANER

Cleaning solution to wipe out the water resistant chalk board marker. PU 1 can (1 liter).

24283-00





LED ALU SNAP-TYPE FRAME

Alu snap-type frame, profile 25 mm, with LED lighting to insert printed backlight foils. Delivery completely with power cable and two thread inserts for wire suspension (either portrait or landscape). For indoor use only. Frame depth 19 mm. Color of lighting: cold white.

59100-A3/91	A3
59100-A2/91	A2
59100-A1/91	A1



CABLE SUSPENSION FOR LED SNAP FRAME (PAIR)

To twist into the snap frame profile, wire cable adjustable in length Ø 1,2 mm with hooks, length 1000 mm. Set consisting of 2 pieces.

25695-00/1000



POSTER HOLDERS



KL STAND

KL base, grey, with aluminium tube Ø 6 mm, lengths 200 and 400 mm, with swivel-type KCLICK adaptor. To be combined with KCLICK frames (to be ordered separately).

- 38400-91/6/200 KL stand 200 mm
- 38400-91/6/400 KL stand 400 mm



KL BASE WITH CARDHOLDER

KL base, grey, with aluminium tube Ø 6 mm, lengths 200 and 400 mm. Cardholder, grey, adjustable viewing angle.

- 36100-03/200 KL base with cardholder 200 mm
- 36100-03/400 KL base with cardholder 200 mm



SHOWCARD STAND K ECO

Rectangular, light plastic base. Colors: grey, black, anthracite. Adjustable aluminium tube with tube fixing, grey and T-piece Ø 9 mm, transparent. Frames to be ordered separately. Please note: to be put underneath pallets or needs to be weighted down by an additional weight when standing free.

- 34224-xx/-620 Adjustable - 320-620 mm
- 34224-xx/-1000 Adjustable - von 500-1000 mm



SHOWCARD STAND K

Rectangular plastic base, adjustable chromium tube 320-620 mm, frame, T-piece and base in OEK standard colors.

- 33525-xx A5
- 33524-xx A4
- 33523-xx A3



SHOWCARD STAND K ROUND

Round plastic base Ø 160 mm, white, adjustable chromium tube 320-620 mm, frame and T-piece in OEK standard colors. With grey and black frames also the base will be supplied in the same color.

- 33535-xx A5
- 33534-xx A4



POSTER HOLDERS

SHOWCARD STAND L

Round base Ø 160 mm, made of plastic with patented "Levistor" rubber plate, white. Adjustable chromium tube 320-620 mm, frame and T-piece in OEK standard colors. With grey and black frames also the base will be supplied in the same color.

- 33425-xx A5
- 33424-xx A4



SHOWCARD STAND KB

Rectangular plastic base, with galvanized metal insert, adjustable chromium tube 320-620 mm, frame, T-piece and base in OEK standard colors.

- 33625-xx A5
- 33624-xx A4
- 33623-xx A3



SHOWCARD STAND NT WITH PLASTIC TUBE

Trapezoidal shaped stainless steel base, adjustable plastic tube 320 - 620 mm, white, frame, T-piece, tube fixing and tube holder in OEK standard colors.

- 34085-xx/01 A5
- 34084-xx/01 A4



SHOWCARD STAND NT WITH CHROMIUM TUBE

Trapezoidal shaped stainless steel base, adjustable chromium tube 320 - 620 mm, frame, T-piece and tube holder in OEK standard colors.

- 34055-xx A5
- 34054-xx A4



SHOWCARD STAND N

Rectangular stainless steel base, adjustable chromium tube 320-620 mm, frame, T-piece and tube holder in OEK standard colors.

- 33045-xx A5
- 33044-xx A4
- 33043-xx A3



SHOWCARD STAND BK

Rectangular, powder-coated metal base, grey, adjustable chromium tube 320-620 mm with lever clamp and tube holder, grey, frame and T-piece in OEK standard colors.

- 33155-xx A5
- 33154-xx A4
- 33153-xx A3



POSTER HOLDERS

SHOWCARD STAND SK

Rectangular, powder-coated metal base, black, adjustable plastic tube 320-620 mm with tube holder, black, frame and T-piece in OEK standard colors.

- 33265-xx A5
- 33264-xx A4
- 33263-xx A3



SHOWCARD STAND SK ECO

Rectangular, powdercoated metal base in black with tube holder base in black. With adjustable plastic tube 320-620 mm, black, frame and T-piece in OEK standard colors.

- 33565-xx A5
- 33564-xx A4
- 33563-xx A3



SHOWCARD STAND SK LAMINATE

Rectangular, powder-coated metal base, black, adjustable plastic tube 320-620 mm with tube holder, black, frame for laminated posters and T-piece in OEK standard colors.

- 33275-xx A5
- 33274-xx A4
- 33273-xx A3





SHOWCARD STAND K GREENLINE
 Rectangular plastic base with aluminium tube Ø 10 mm, fixed length 310 mm, T-piece and frame Greenline. Colors: natura, biological green.

- 33515-G-xx A5
- 33514-G-xx A4
- 33513-G-xx A3

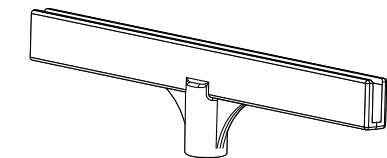

ACRYLIC SHOWCARD STAND K
 Round K base, MF rod 75 mm, holder 150 resp. 210 mm with acrylic cover A5 resp. A4 portrait, transparent.

- 33505-00 A5
- 33504-00 A4



SHOWCARD STAND BD-MINI
 BD base Ø 160 mm, silvergrey, adjustable chrome tube 600-1200 mm with lever clamp, frame and T-piece in OEK standard colors.

- 33284-xx A4
- 33283-xx A3



POSTER HOLDERS

SHOWCARD STAND BD-ECO

BD base Ø 255 mm, silvergrey, adjustable chromium tube 800-1600 mm with lever clamp, frame and T-piece in OEK standard colors.

33294-xx	A4
33293-xx	A3
33292-xx	A2



SHOWCARD STAND BD

BD base Ø 255 mm, silvergrey, adjustable chromium tube 1000-1700 mm, frame and T-piece in OEK standard colors.

33314-xx	A4
33313-xx	A3
33312-xx	A2



ACRYLIC SHOWCARD STAND BD

BD base Ø 160 mm, silvergrey, adjustable chromium tube 320-620 mm with lever clamp, acrylic T-piece 210 mm and acrylic cover A4 portrait.

33342-03/00/-0620





SHOWCARD STAND ALU-BD WITH FLAG SUSPENSION

BD base Ø 255 mm, silvergrey, adjustable aluminium tube 1300-2500 mm, with special bolt to hang flags, banners, etc.

33353-33/-2500/33



GALLOW SHOWCARD STAND QP

BD base Ø 255 x 5 mm, silvergrey, with support plate, qP fixed aluminium tube 2000 mm, gallow pre-mounted with gusset plate, two end caps, grey, two suspension hooks, transparent, incl. screws and hexagonal key.

38790-91/1900/0700 With 1 gallow length 700 mm for A1

38790-91/1900/0550 With 1 gallow length 550 mm for A2

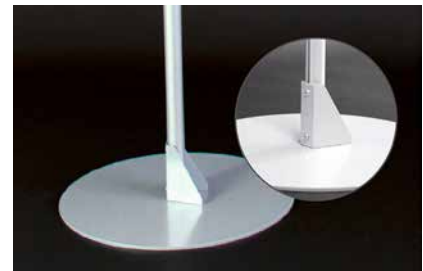

GALLOW SHOWCARD STAND ALU-BD FIXED

BD base Ø 255 mm, silvergrey, fixed aluminium tube 1600 mm, with 1 or 2 gallows Ø 20 mm, length 400 mm (without frame and tube clips).

38410-33/1600 With 1 gallow

38420-33/1600 With 2 gallows



POSTER HOLDERS

**GALLOW SHOWCARD STAND ALU-BD
ADJUSTABLE**

BD base Ø 255 mm, silvergrey, adjustable aluminium tube 1000-1900 mm, with 1 or 2 gallows Ø 16 mm, length 400 mm (without frame and tube clips).

38411-33/-1900 With 1 gallow

38421-33/-1900 With 2 gallows

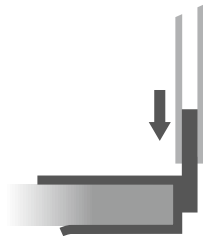
**EURO PALLET WEATHER-RESISTANT
SHOWCARD STAND**

Pallet claw to attach onto Euro pallets, made of zinc metal and torsionally connected with aluminium tube adjustable up to 800 mm, with T-piece 90 mm in OEK standard colors. Showcard frames to be ordered separately.

33770-xx/-800



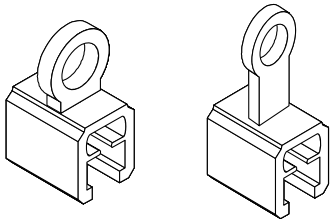

SUSPENSION RING 90°

With ring (Ø 9mm) to suspend frames 90°, for lateral poster insert, transparent.

21300-00 series 100
22300-00 Series 200

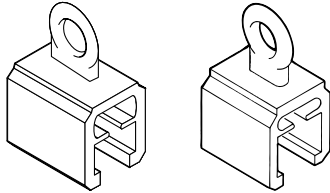

SUSPENSION RING PARALLEL

With ring (Ø 8mm) to suspend frames parallel, for lateral poster insert, transparent.

21310-00 series 100
22310-00 Series 200

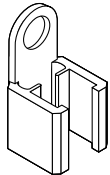

SUSPENSION RING SIDEWAYS

To suspend frames series 100 with poster insert on top, Ø 9 mm, transparent.

21361-00

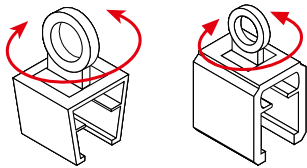

SUSPENSION RING SWIVEL TYPE

With ring (Ø 8mm) to suspend frames, rotation in any position, for lateral poster insert, transparent.

21315-00 series 100
22315-00 Series 200

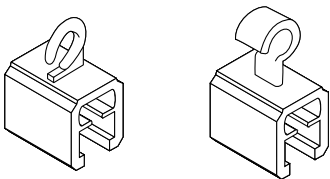

SUSPENSION HOOK SHORT

With hook to suspend frames with lateral poster insert, for max. Ø 7,5 mm, transparent.

21320-00 series 100
22320-00 Series 200

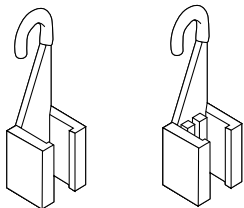

SUSPENSION HOOK (PAIR)

With hook to suspend frames with top poster insert, for max. Ø 6 mm, length hook = 50 mm, transparent.

21370-00 series 100
22370-00 Series 200

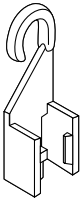

ACCESSORIES FOR POSTER FRAMES

**SUSPENSION HOOK SHORT (PAIR)**

Short version with hook to suspend frames series 100 with top poster insert, for max. Ø 6 mm, length hook = 40 mm, transparent.

21360-00

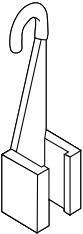
**SUSPENSION HOOK (F2-LONG)**

To suspend frames series 200 with poster insert on top from tubes Ø 12 mm, length of hook = 58 mm, clear (the same hook is used on right and left hand side).

22371-00

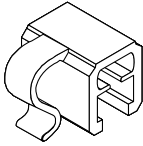
**HANGING HOOK**

To attach frames series 100 with onto wires etc. with max. Ø 10 mm, for frames with lateral poster insert, transparent.

21400-00

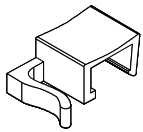
**FASTENING CLIP FOR WIRES (PAIR)**

To attach frames series 100 onto wires, shopping trolleys, etc. with max. Ø 6mm, transparent.

21430-00

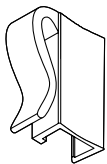
**WIRE HOOKS (PAIR)**

For parallel attachment of frames series 100 onto wires, baskets etc. with max. Ø 10 mm, transparent.

21431-00

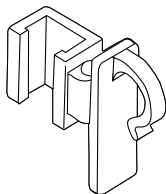
**SUSPENSION HOOK 2-PART (PAIR)**

To attach frames series 100 with top poster insert onto wires, baskets, etc. with max. Ø 12 mm, grey.

21410-03



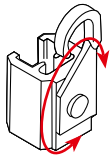

HANGING HOOK SHORT SWIVEL TYPE (PAIR)

To attach frames with top poster insert to wires etc. with max. Ø 8 mm (series 100) or max. Ø 5 mm (series 200), transparent. Length hook: series 100 = 32 mm, series 200 = 50 mm.

- 21330-00 series 100
- 22350-00 Series 200

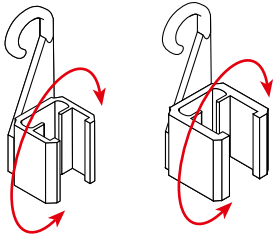

HANGING HOOK BIG SWIVEL TYPE (PAIR)

To attach frames with top poster insert to wires etc. with max. Ø 10 mm, length hook = 50 mm, transparent.

- 21331-00 series 100
- 22330-00 Series 200



SUSPENSION HOOK WIRE SWIVEL TYPE (PAIR)

To attach frames series 100 with top poster insert onto wires etc. with max Ø 7 mm, length of hook = 37 mm, transparent.

- 21325-00

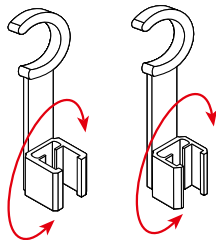

TUBE CLIP SWIVEL-TYPE (PAIR)

To suspend frames from round rails, tubes, etc. with max Ø 22 mm, length tube clip 85 mm, transparent.

- 21610-00 Series 100
- 22610-00 Series 200

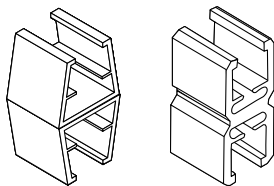

FRAME CONNECTOR

To connect frames of the same series, transparent.

- 21000-00 Series 100
- 22000-00 Series 200

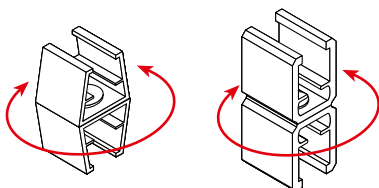

FRAME CONNECTOR SWIVEL TYPE

To connect frames of the same series, rotating, transparent.

- 21010-00 Series 100
- 22010-00 Series 200



ACCESSORIES FOR POSTER FRAMES

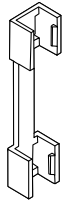

FRAME CONNECTOR PORTRAIT

To connect frames series 100 with top poster insert, length = 64 mm, transparent.

21020-00

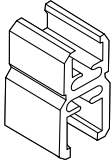

FRAME CONNECTOR S100/200

To connect frames series 100 with frames series 200, transparent.

21030-00

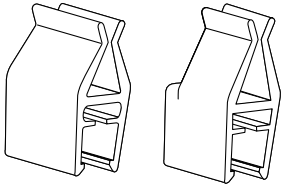

PROMOTION CARD CLIP

To attach posters or signs onto frames, in standing or hanging position, transparent. Series 100: poster thickness 0,3-1,0 mm. Series 200: poster thickness 0,3-2,0 mm.

21920-00

Series 100

22920-00

Series 200

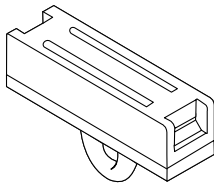

MAGNETIC RING RECTANGULAR

With 1 magnet, for attachment of frames with hooks to ceilings, profiles etc., magnetic force up to 2,8 kgs. Ø ring 8 mm, transparent.

20601-00

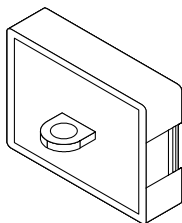

MAGNETIC RING SQUARE

With 2 magnets, for attachment of frames with hooks to ceilings, profiles etc., magnetic force up to 5,6 kgs. Ø ring 8 mm, white.

20602-01

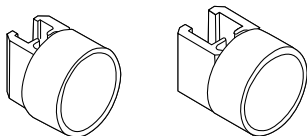

MAGNETIC FASTENER ROUND

For the direct attachment of frames series 100 to metallic surfaces, Ø 30 mm, magnetic force up to approx. 4 kgs. Colors: white, grey, red, black. Series 200 upon request.

21200-xx

series 100



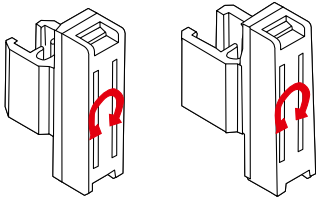

**MAGNETIC FASTENER
RECTANGULAR SWIVEL TYPE**
With 1 magnet, 360° rotatable,
magnetic force up to approx. 2,8 kgs,
transparent.

22220-00 Series 200
21220-00 series 100

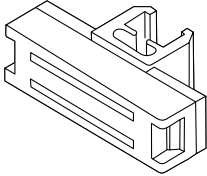

**MAGNETIC FASTENER
RECTANGULAR 90°**
With 1 magnet, in 90° position to
frame series 100, magnetic force up
to approx. 2,8 kgs. Colors: transparent,
grey.

21260-xx

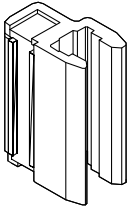

**MAGNETIC FASTENER
RECTANGULAR PARALLEL**
Magnet with adaptor to fix parallel to
frame series 100, transparent.

21219-00

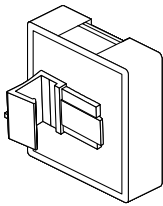

**MAGNETIC FASTENER SQUARE
PARALLEL**
With 2 magnets, in parallel position to
frame, magnetic force up to approx.
5,6 kgs. Colors: white, adaptor trans-
parent.

21230-01 series 100
22230-01 Series 200

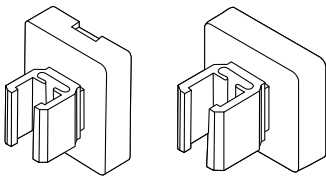

MAGNETIC FASTENER SQUARE 90°
With 2 magnets, in 90° position to
frame, magnetic force up to approx.
5,6 kgs. Colors: white, adaptor trans-
parent.

21250-01 series 100
22250-01 Series 200

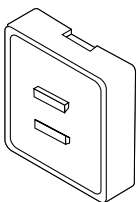

**MAGNETIC FASTENER SQUARE
WITHOUT ADAPTOR**
With 2 magnets, for variable fixing of
the corresponding adaptors (either
parallel or 90° version), magnetic force
up to approx. 5,6 kgs, white.

21240-01

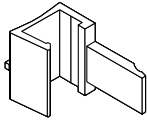

ACCESSORIES FOR POSTER FRAMES

**ADAPTOR PARALLEL**

For fixing to magnetic fastener, transparent.

21231-00 series 100
22231-00 Series 200

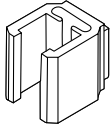
**ADAPTOR 90°**

For fixing to magnetic fastener item number 21240-01, transparent.

21251-00 series 100
22251-00 Series 200

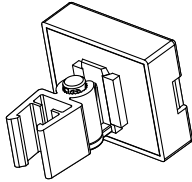
**MAGNETIC FASTENER SQUARE SWIVEL TYPE**

White magnet with 2 magnets, magnetic force up to approx. 5,6 kgs, adjustable adaptor transparent offering different angles for inclined presentation, suitable for frames series 100.

20377-01

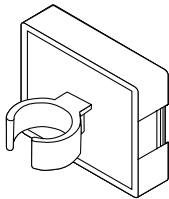
**MAGNETIC TUBE CLIP**

With 2 magnets, for tubes Ø 12 mm, magnetic force up to approx. 5,6 kgs, white. We recommend to use 2 clips per application.

21255-01

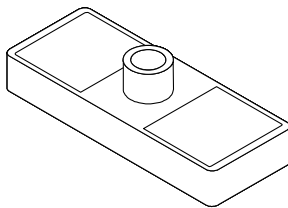
**MAGNETIC BASE MF4**

Plastic base with 4 magnets, magnetic force up to approx. 11 kgs, to hold tubes Ø 12 mm. Size: 100x40 mm, grey.

20370-03



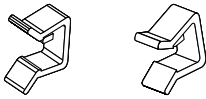

RETAINING CLIP

Prevents posters from falling out of frames, transparent.

- 21940-00 Series 100
- 22940-00 Series 200

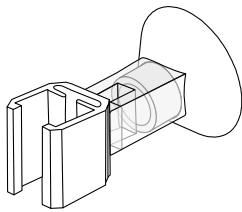

SUCTION PAD

To attach to frames series 100 onto glass or smooth surfaces, 2-piece, to be mounted for either parallel or 90° fixing, transparent.

21706-00

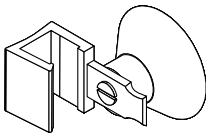

SUCTION PAD PARALLEL

To attach frames series 200 onto glass or smooth surfaces, transparent.

22705-00

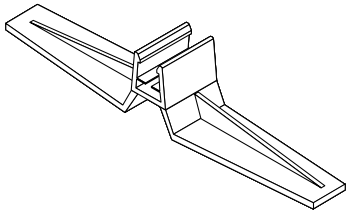

RA1 FRAME BASE SUPPORT

To support frames in an upright position, series 100 1-piece, series 200 2-piece, length 140 mm, transparent.

- 21750-00 Series 100
- 22750-00 Series 200

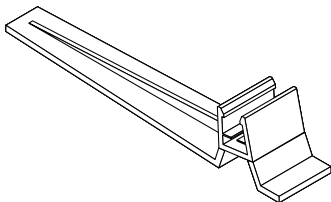
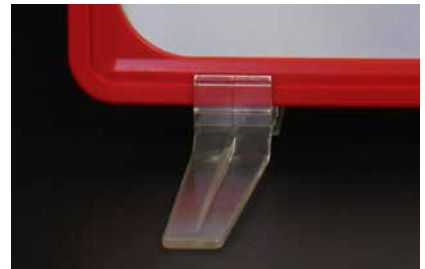

RA2 FRAME BASE SUPPORT

To support frames in an inclined position, series 100 1-piece, series 200 2-piece, length 140 mm, transparent.

- 21760-00 Series 100
- 22760-00 Series 200



ACCESSORIES FOR POSTER FRAMES

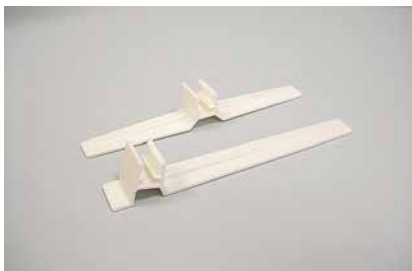

FRAME BASE SUPPORT GREENLINE

To support Greenline frames in an upright or inclined position. Color: natural.

- 21750-G-xx Upright
- 21760-G-xx 15° inclined

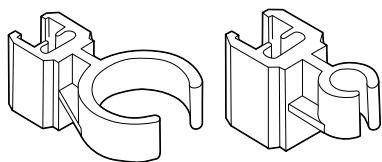
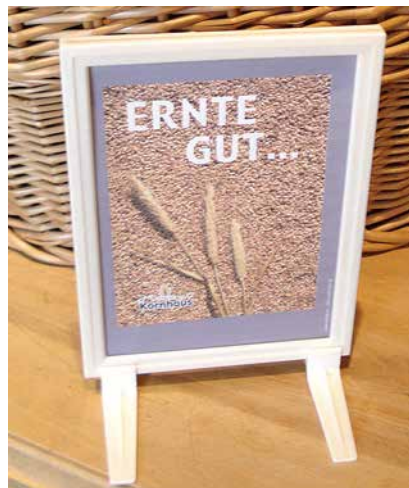

TUBE CLIPS (SERIES 100)

Tube clips to attach frames series 100 to tubes with different diameters. Colors: transparent, white.

- 21508-xx Ø 8 mm
- 21510-xx Ø 10 mm
- 21512-xx Ø 12 mm
- 21514-xx Ø 14 mm
- 21518-xx Ø 18 mm
- 21522-xx Ø 22 mm
- 21528-xx Ø 28-35 mm
- 21535-00 Ø 35-40 mm (only transparent)

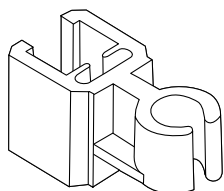

TUBE CLIPS (SERIES 200)

Tube clips to attach frames series 200 to tubes with different diameters, transparent.

- 22512-00 Ø 12 mm
- 22514-00 Ø 14 mm
- 22516-00 Ø 16 mm
- 22520-00 Ø 20 mm
- 22522-00 Ø 22 mm
- 22528-00 Ø 28-35 mm

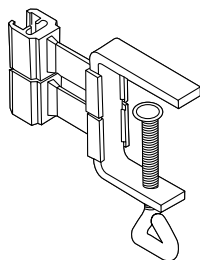

FLEXIBLE CLIP WITH G-CLAMP

To fix frames series 100 to shelves etc. With thickness up to 40 mm, not mounted, white. Screw clamp zinc coated.

- 21110-26



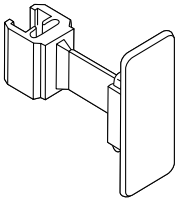

FLEXIBLE CLIP WITH ADHESIVE

To fix frames series 100 to smooth surfaces, 2-parts not mounted, white. We recommend to use 2 clips per frame fixing.

21119-26

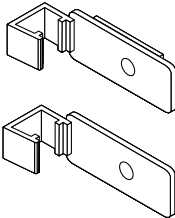

WALL FASTENER SERIES 100

Transparent.

21130-00

screw mounting

21131-00

with adhesive

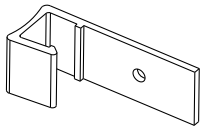

WALL FASTENER RECTANGULAR SERIES 200

transparent

22140-00

Screw mounting

22140-00/K

With adhesive

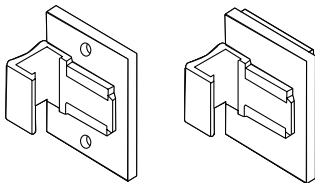

WALL FASTENER SQUARE SERIES 200

transparent

22132-00

Screw mounting

22135-00

With adhesive

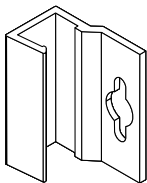

KEYHOLE FASTENER

For parallel fixing of frames series 100 to hooks or screws, transparent.

21180-00



ACCESSORIES FOR POSTER FRAMES

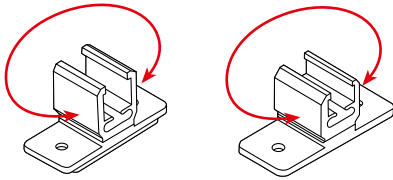

FASTENER WITH ROTARY CLIP

For mounting with screws or with double adhesive tape, 360° rotating clip, transparent.

- 21120-00 Series 100
(screw mounting)
- 22120-00 Series 200
(screw mounting)
- 21125-00 Series 100
(with adhesive)
- 22125-00 Series 200 (with
adhesive)

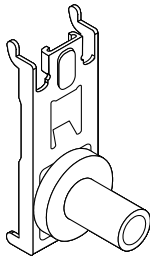

PEGBOARD HOOK WITH TUBE HOLDER

To be fixed to pegboards with hole spacing 30 mm (corresponds to European standard), zinc plated with tube holder, grey, suitable for tubes Ø 12 mm.

21720-03



CARDBOARD CLAMP 20

To attach frames series 100 onto boxes, baskets and cartons with up to 20 mm material thickness, 2-piece, transparent.

21715-00

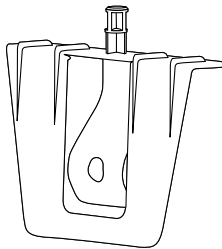

CARDBOARD CLAMP 140 WITH MF CONNECTOR

To be attached to baskets, boxes or similar with a thickness up to 22 mm. Set consisting of cardboard clamp 40, black, with hinge, MF connector 50 mm black, and T-piece in OEK standard colors.

35550-xx



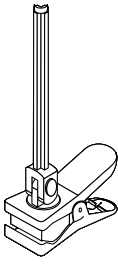

CLAMP ALLROUNDER

360° rotatable, rod length 155 mm, suitable for T-piece Ø 10 mm, clamp range approx. 8 - 34 mm, made of plastic with rubber inlay. Colors: white, grey, red, black (T-piece and frame to be ordered separately).

20560-xx

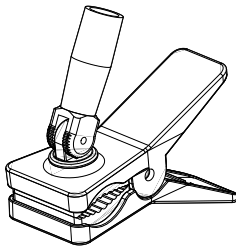

DISPLAY CLAMP TO HOLD TUBES Ø 12 MM

Clamp 360° rotatable to hold tubes Ø 12 mm. Clamp range approx. 8-34 mm, made of plastic with an inner rubber inlay. Colors: white, grey, red.

20580-xx

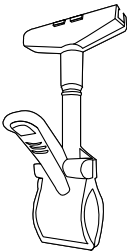

UNIVERSAL CLAMP 25

Stable clamp attach frames from series 100 onto textile stands, baskets, shelves, etc. with material thickness up to max. 25 mm. With rubber inlay: prevents any scratching and secures a tight fit on slippery surfaces. Including T-piece 70 mm, transparent.

20571-00

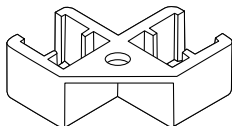

SQUARE HANGER

To connect frames series 100 at a 90° angle, with hole for suspension cord, transparent.

21040-00



ACCESSORIES FOR POSTER FRAMES

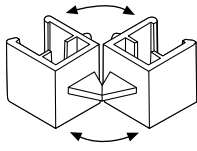

HINGED HANGER

For triangular and square connections, suitable for frames series 200, transparent.

22040-00

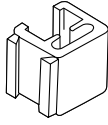

ADAPTOR PARALLEL KLICK

To combine frames series 100 with all Klick fasteners (see Klick accessories), transparent.

21060-00

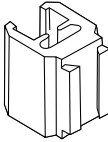

ADAPTOR 90° KLICK

To combine frames series 100 with all Klick fasteners (see Klick accessories), transparent.

21070-00

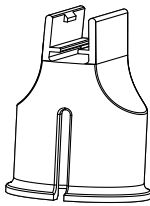

BOTTLE HOLDER

For all kind of PET bottles to fix show-card frames series 100, transparent.

20025-00

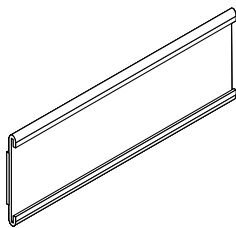

C-RAIL

With double adhesive tape, width 28 mm, white.

21660-01/1000 Length 1000 mm

21660-01/2000 Length 2000 mm

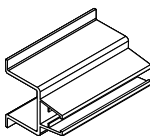

FASTENER 90° FOR C-RAIL

To clamp into C-rail, suitable for frames series 100, transparent.

21663-00

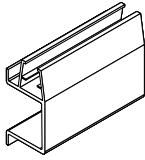

FASTENER PARALLEL FOR C-RAIL

To clamp into C-rail, suitable for frames series 100, transparent.

21665-00

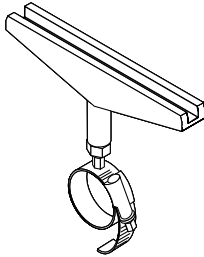

TUBE CLAMP

To fix frames to tubes, clamp zinced, stepless adjustable screw. T-piece to be ordered separately.

21740-00 Ø 25-40 mm

21741-00 Ø 40-60 mm

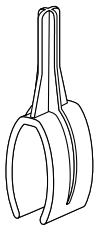

KS 1 OVAL TUBE CLIP

Showcard holder for textiles stand with oval tube 20 x 35 mm, transparent. T-piece to be ordered separately.

20530-00

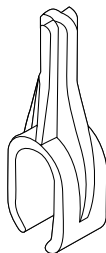

KS 1 A FLAT OVAL TUBE CLIP

Showcard holder for textiles stand with flat oval tube 15 x 35 mm, transparent. T-piece to be ordered separately.

20531-00

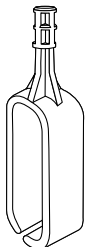

KS 3 OVAL TUBE CLIP

Showcard holder for textiles stand with oval tube 20 x 50 mm, transparent. T-piece to be ordered separately.

20534-00

ACCESSORIES FOR POSTER FRAMES

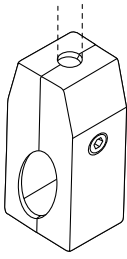

KS 2 O CLAMP FOR OVAL TUBE

Showcard holder for textiles stand with oval tube 20 x 35 mm, to be screwed, with chromium tube 160 mm, black. T-piece to be ordered separately.

20533-10/160

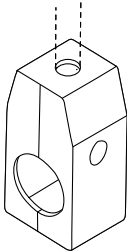

KS 2 R CLAMP FOR ROUND TUBE

Showcard holder for textiles stand with round tubes Ø 25 mm, to be screwed, with chromium tube 160 mm, black. T-piece to be ordered separately.

20532-10/160



SHOWCARD HOLDER DK WITH SPRING CLAMP

DK holder (pair), made of plastics, grey, with spring clamp, for wires with Ø 4-8 mm, vertical wire distance of min. 18 mm, adjustable aluminium tube 250-500 mm, frame A4 and T-piece in OEK standard colors.

35434-xx/-500



SHOWCARD HOLDER DK

DK holder (pair), made of plastics, grey, for wires with Ø 4-8 mm, vertical wire distance of min. 18 mm, adjustable chromium tube 320-620 mm, frame A4 and T-piece in OEK standard colors.

35424-xx

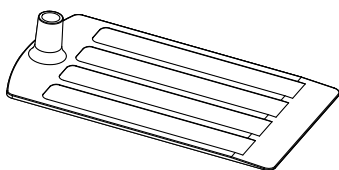

BASE K ECO

Light weight base made of plastics with tube holder Ø 12 mm. Colors: grey, black, anthracite. Size: 124x210 mm.

20348-xx



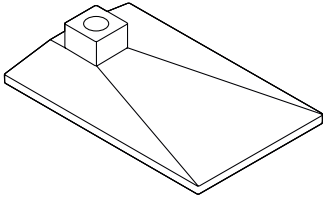

BASE KL

Made of plastics for tubes Ø 12 mm or Ø 6 mm, colors: white, grey. Size: 140x90 mm.

- 20380-xx Ø 12 mm
- 20380-xx/12-6 Ø 6 mm

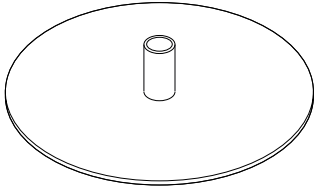

BASE K ROUND

Made of plastics, round, for tubes Ø 12 mm, colors: transparent, white, grey, red, black. Size: Ø 160 mm, material thickness 4 mm.

20340-99/xx

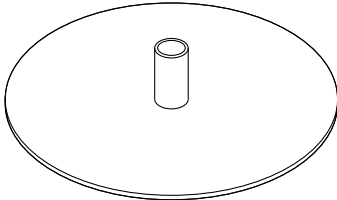

BASE L

Made of plastics with Levistor rubber plate, sucking to all smooth surfaces, for tubes Ø 12 mm, colors: white, grey, black. Size: Ø 160 mm, material thickness 4 mm.

20340-xx

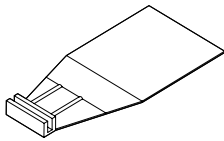

BASE RS 200X90

Made of plastics to fix frames series 100, grey. Size: 200x90 mm.

20352-03

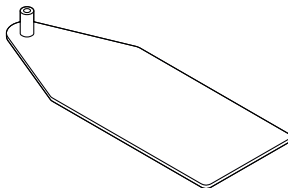

BASE RS

Made of plastics, to fix t-pieces or chromium tubes Ø 12 mm, colors: white, grey, red. Size: 250x90x3 mm.

20390-xx

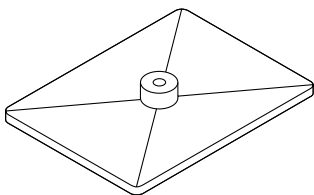

BASE K

Made of plastics, with tube holder for tubes Ø 12 mm, in OEK standard colours. Size: 200x150 mm. Also available with zinc metal inlay.

- 20350-xx Base K
- 20351-xx With metal inlay

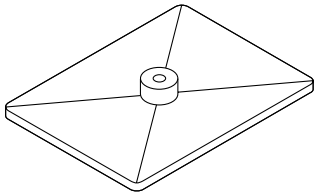

ACCESSORIES FOR POSTER FRAMES

**BASE K GREENLINE**

Rectangular base plate made of organic plastics with tube holder for tubes \varnothing 12 mm. Size: 200x150 mm. Colors: natural off-white, organic green.

20350-G-xx

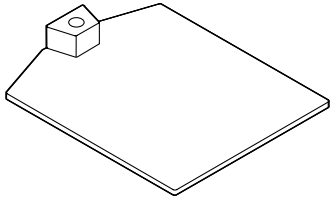
**BASE KB**

Made of plastic with galvanized metal plate, for tubes \varnothing 12 mm, in OEK standard colors. Size: 200x160x6 mm.

20360-xx

**BASE N**

Plate of stainless steel with tube holder \varnothing 12 mm made of plastics in OEK standard colors. Size: 185x160 x1,5 mm.

20300-xx

**BASE NT**

Trapeze shaped plate of stainless steel with plastic tube holder \varnothing 14 mm or \varnothing 12 mm in OEK standard colors. Size: 165(80)x160x1,5 mm.

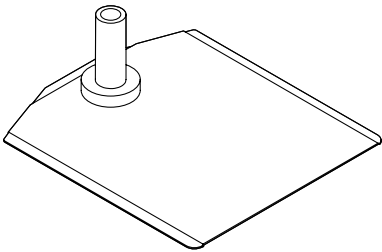
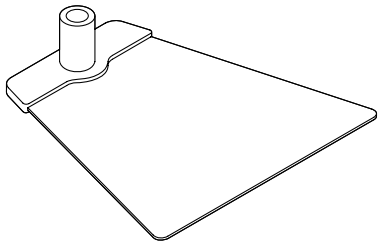
20400-xx

\varnothing 14 mm

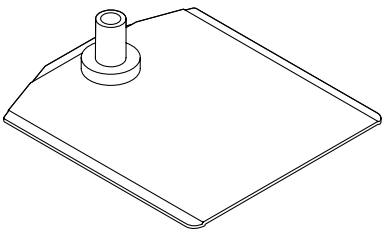
**BASE BK**

Metal base powder coated grey with tube holder \varnothing 12 mm made of plastics, grey. Size: 185x160x2,5 mm.

20310-03/03

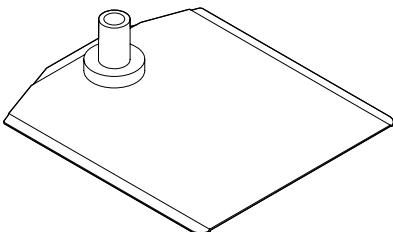
**BASE SK**

Metal base powder coated black with tube holder \varnothing 12 mm made of plastics, black. Size: 185x160x 1,5 mm.

20320-10



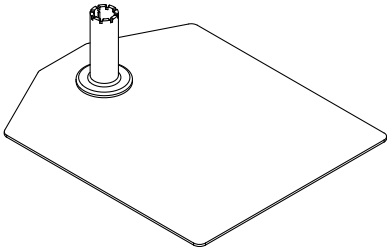

BASE SK ECO

Metal base powder coated in RAL 9007, also available in black. Available in grey similar RAL 9007 with tube holder Ø 12 mm, grey, or in black with tube holder in black. Size: 195x160x 1,5 mm.

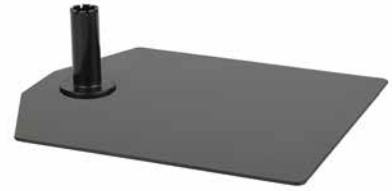

20325-xx

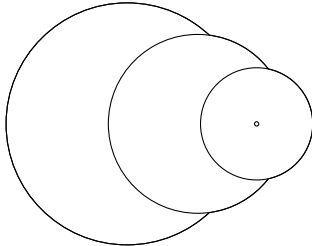

BASE BD

Heavy steel plate without tube holder, powder coated. Colors: silvergrey, black.

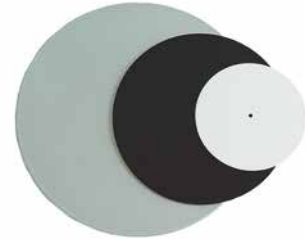

- 20330-xx Ø 160 mm, drilling for M5 material thickness: 4 mm (0,6 kgs)
- 20331-xx/3 Ø 255 mm, drilling for M8 material thickness: 3 mm (1,2 kgs)
- 20331-xx Ø 255 mm, drilling for M8 material thickness: 5 mm (2,0 kgs)
- 20334-33 Ø 350 mm, drilling for M8 material thickness: 5 mm (3,8 kgs)

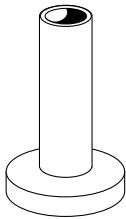

SB TUBE HOLDER FOR TUBES Ø 12 MM

For self-mounting, suitable for bases N, BK, SK, BD Ø 160 mm as well as to special devices with hole Ø 5,4, mounted with nut M5 and screw, colors: grey, black, silvergrey.



20200-xx



HEXAGONAL KEY

To mount SB tube holder, black.

96-240103

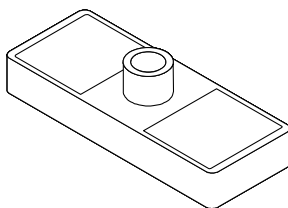

MAGNETIC BASE MF2

Plastic base with 2 magnets, magnetic force up to approx. 5,6 kgs, for tubes Ø 12 mm, Size: 100x40 mm, grey.



20372-03

ACCESSORIES FOR POSTER FRAMES

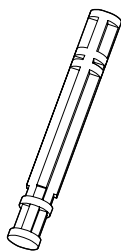

MF CONNECTOR

Made of plastics, transparent.

20170-00	50 mm
20171-00	75 mm
20172-00	110 mm

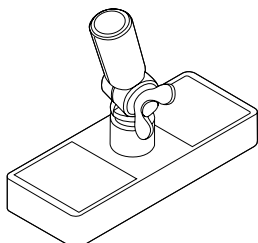

MAGNETIC BASE MF WITH HINGE

Plastic base with 4 magnets, magnetic force up to approx. 11 kgs. Hinge for base grey for tubes Ø 12 mm, for an inclined positioning and for chrome tubes. Size: 100x40 mm.

20373-03



HINGE FOR BASE

Hinge connector between bases with tube holders Ø 12 mm (such as N, BK, SK, L, MF) and tubes Ø 12 mm, for an inclined presentation adjustable, made of plastic, grey.

20271-03 Hinge for Base



MAGNETIC BASE 60X38 WITH HINGE

Plastic base with 4 magnets, magnetic force up to approx. 10 kgs, with angle adjustable adaptor for tubes Ø 10 mm, Color: white, anthracite.

20378-xx



MOUNTING SET MAGNET Ø 50 MM

Round zinced magnet, magnetic force up to approx. 18 kgs. To fit on alu profile frames or customized solutions.

21450-00-E

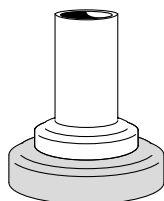

MAGNETIC BASE Ø 50 MM WITH TUBE HOLDER

Round zinced magnet, magnetic force up to approx. 18 kgs, with tube holder grey for tubes Ø 12 mm.

20375-03



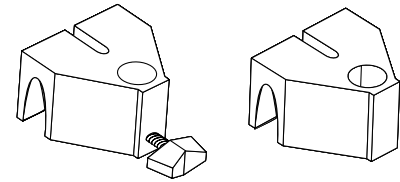

SHOWCARD HOLDER DK (PAIR)

DK holder (pair) grey, suitable for wires with \varnothing 4 - 8 mm, and a vertical wire distance of min. 18 mm, suitable for chromium tubes with \varnothing 12 mm.

20545-03



PALLET CLAW

To attach onto Euro or Chep pallets, made of galvanized metal, to put on tubes \varnothing 12 mm.

90-39040

For Euro pallets

90-39020

For Chep pallets



PALLET CLAW WEATHER-RESISTANT

To attach onto Euro pallets, made of galvanized metal, to put on crimped tubes \varnothing 12 mm.

90-39041

CHROME TUBE

Chrome tube in fixed length/size, top with reduced diameter, top \varnothing : 10 mm, bottom \varnothing : 12 mm. Also available with external threaded bolt M8 or M10.

20100-35/xxxx	160 mm
20100-35/0310	310 mm
20100-35/0410	410 mm
20100-35/0600	600 mm



ACCESSORIES FOR POSTER FRAMES

ADJUSTABLE CHROME TUBE

Adjustable chromium tube, inner tube \varnothing : 10 mm, outer tube \varnothing : 12 mm. Also available with external threaded bolt M8 or M10.

- 20140-35/-0620 320-620 mm
- 20140-35/-0900 450-900 mm
- 20140-35/-1200 600-1200 mm



ADJUSTABLE CHROME TUBE WITH LEVER CLAMP

Adjustable chromium tube with plastic lever clamp grey, inner tube \varnothing : 10 mm, outer tube: \varnothing 12 mm.

- 20144-03/-0620 320-620 mm
- 20144-03/-1200 600-1200 mm



ADJUSTABLE ALUMINIUM TUBE

Adjustable aluminium tube with screw connector, grey, \varnothing inner tube: 9 mm, \varnothing outer tube: 12 mm.

- 15800-91/03/-0620 320-620 mm
- 15800-91/03/-1000 500-1000 mm



ADJUSTABLE PLASTIC TUBE FOR T-PIECE \varnothing 9 MM

Adjustable plastic tube (glass-fiber reinforced) with screw connector black, inner tube \varnothing : 9 mm (to use with T-piece \varnothing 9mm), outer tube \varnothing : 12 mm.

- 20160-10/-0620 adj. 320-620 mm
- 20160-10/-1200 adj. 620-1200 mm
- 20160-10/-1600 adj. 820-1600 mm



ADJUSTABLE PLASTIC TUBE FOR T-PIECE \varnothing 10 MM

Adjustable plastic tube (glass-fiber reinforced) with screw connector black, inner tube \varnothing : 9 mm with bolt (to be used with T-pieces \varnothing 10 mm), outer tube \varnothing : 12 mm.

- 20161-10/-0620 B adj. 320-620 mm



PLASTIC TUBE NT

Adjustable plastic tube 320-620 mm, white with tube fixing in OEK standard colors, inner tube \varnothing : 10 mm, outer tube \varnothing : 14 mm.

20167-01/xx



DEKOLINE TUBE

Fixed aluminium tube \varnothing 16 mm, length 320 mm.

15710-91/0320 anodised aluminium
15710-10/0320 black



TWINSET TUBE

Fixed aluminium tube \varnothing 16 mm, length 320 mm, with bolt on top (\varnothing 10 mm).

15712-91/0320 anodised aluminium
15712-10/0320 black



CHROME TUBE BD

Adjustable chromium tube 1000 - 1700 mm, with bolt on top for T-piece \varnothing 10 mm, mounted with tube holder in black or silvergrey, suitable for BD base \varnothing 255 mm and \varnothing 350 mm, inner tube \varnothing : 15mm, outer tube \varnothing : 18 mm.

20176-xx



ALUMINIUM TUBE BD

Adjustable aluminium tube 1000 - 1900 mm, with bolt on top to take T-piece \varnothing 10 mm, mounted with tube holder in black or silvergrey, suitable for BD bases \varnothing 255 mm and \varnothing 350 mm, inner tube \varnothing 16 mm, outer tube \varnothing 20 mm.

15736-91/-1900/10



ACCESSORIES FOR POSTER FRAMES

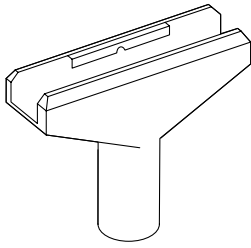

T-PIECE 60 MM SERIES 100 Ø 10 MM

Recommended for frames DIN A6 - DIN A5, colors: OEK standard colors, transparent.

20010-xx

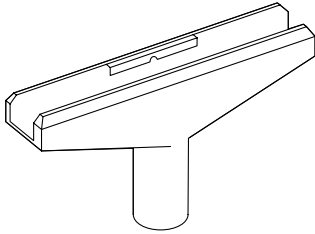

T-PIECE 90 MM SERIES 100 Ø 10 MM

Recommended for frames DIN A4 - DIN A3, colors: OEK standard colors, additional colors, transparent, metallic silver, silver, chromium.

20011-xx

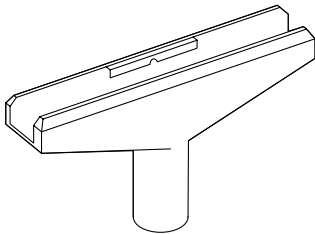

T-PIECE 90 MM SERIES 100 Ø 9 MM

Recommended for frames DIN A4 - DIN A3, suitable for tubes ø 9mm. Colors: OEK standard colors, transparent.

20011-xx/09

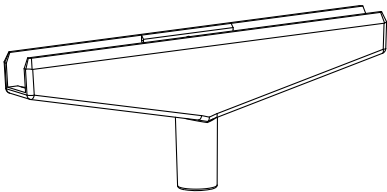

T-PIECE 160 MM Ø 10 MM

Recommended for larger frame sizes, colors: OEK standard colors, transparent.

20012-xx

Series 100

20022-xx

Series 200

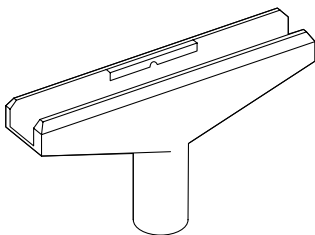

T-PIECE GREENLINE

T-piece 90 mm, series 100, Colors: natural, organic green.

20011-G-xx

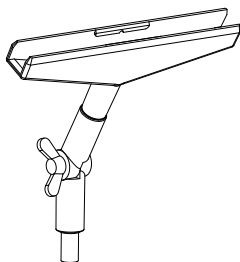

HINGE FOR T-PIECE

Made of plastics in grey, hinge connector between tube (ø 10 mm) and T-piece, upper hinge part ø 12 mm with integrated MF connector 50 mm, for inclined presentation of showcard frames.

20269-03



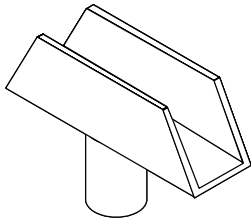

T-PIECE SERIES 500

Suitable for woodline- and alu-profile frames, available for tubes \varnothing 10 mm and \varnothing 16 mm, length 95 mm. Colors: transparent, black.

- 20053-xx \varnothing 10 mm
- 20050-xx \varnothing 16 mm

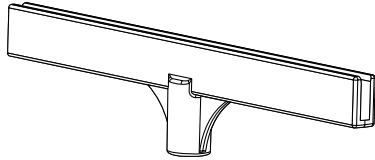

HOLDER FOR ACRYLIC POCKETS

Suitable for tubes \varnothing 10 mm, to hold acrylic pockets incl. inlay with a max. thickness between 3,8-4,3 mm, transparent.

- 20060-00 holder 210 mm
- 20061-00 holder 150 mm

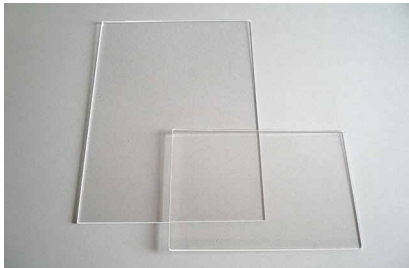
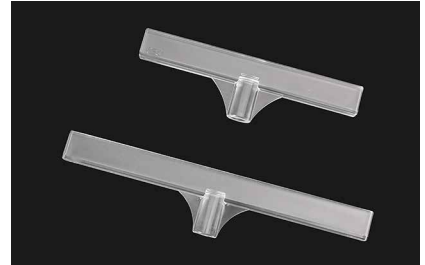

ACRYLIC POCKET

Suitable for holder 150 mm or 210 mm, bent acrylic with 2 mm thickness, total thickness 4 mm, transparent.

- 27100-A5/20 DIN A5 portrait
- 27101-A5/20 DIN A5 landscape
- 27100-A4/20 DIN A4 portrait
- 27101-A4/20 DIN A4 landscape



BASE PLINTH FOR TWIN-SET BASIC FRAME

To take tubes \varnothing 10 mm, height 36 mm, anthracite.

- 20030-7016

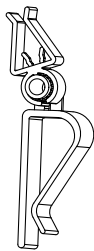

CARDBOARD CLAMP 20 FOR ACRYLIC COVER

Suitable for acrylic cover 3,5-4,5 mm, to attach onto boxes, cartons, trays, etc., with material thickness up to 20 mm, transparent. We recommend to use two clamps per acrylic cover.

- 24715-00



ACCESSORIES FOR POSTER FRAMES

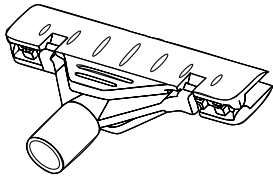

CLAMPHOLDER FOR TUBE

Clampholder to fit tubes ø 10 mm, 100 mm wide clamp to take posters with max. 5 mm thickness, transparent.

17050-00



PVC PROTECTIVE COVERS

Suitable for showcard frames of same DIN size, non-reflective, transparent.

29000-A6/02	A6 (0,2 mm)
29000-A5/02	A5 (0,2 mm)
29000-A4/02	A4 (0,2 mm)
29000-A3/02	A3 (0,2 mm)
29010-A2/05	A2 (0,5 mm)
29010-A1/05	A1 (0,5 mm)
29010-A0/05	A0 (0,5 mm)
29010-B2/05	500 x 700 mm (0,5 mm)
29010-B1/05	700 x 1000 mm (0,5mm)

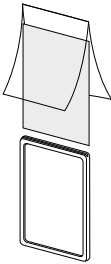
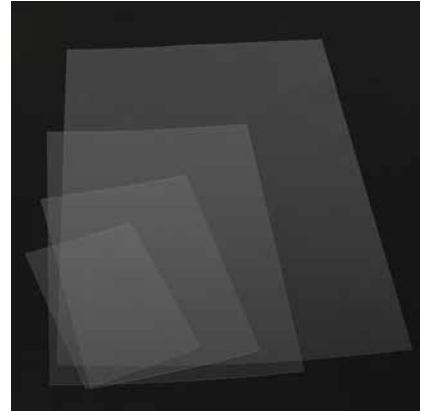

PVC POSTER PROTECTORS

Suitable for showcard frames of same DIN size, folded short side, non-reflective, transparent.

29100-A6/02	DIN A6 (0,2 mm)
29100-A5/02	DIN A5 (0,2 mm)
29100-A4/02	DIN A4 (0,2 mm)
29100-A3/03	DIN A3 (0,3 mm)
29100-A2/03	DIN A2 (0,3 mm)
29100-A1/04	DIN A1 (0,4 mm)



PVC POSTER PROTECTORS FOLDED LONG SIDE

Suitable for showcard frames of same DIN size, folded long side, non-reflective, transparent.

29101-A6/02	DIN A6 (0,2 mm)
29101-A5/02	DIN A5 (0,2 mm)
29101-A4/02	DIN A4 (0,2 mm)
29101-A3/03	DIN A3 (0,3 mm)



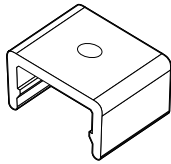

CEILING FASTENER/ CLIP

For direct fixing of Poster Rail II and III or profile frames series 500 to ceiling, hole Ø 3,5 mm, transparent.

25181-00

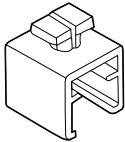
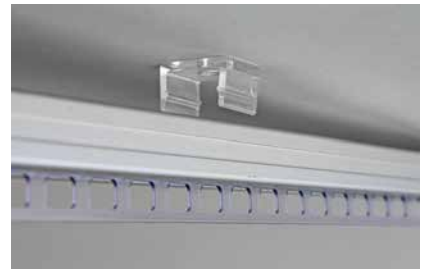

FRAME CLIP FOR POSTER RAIL II AND III - SERIES

For direct twist into the rail profile, to suspend frames series 100 with insert by side, transparent.

25740-00

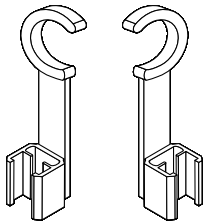

TUBE CLIP, SWIVEL TYPE (PAIR), SERIES 500

To suspend alu profile frames and woodline frames from poster rail round tube, etc. with max. Ø 22 mm, length tube clip = 85 mm, transparent.

25521-00



WOODEN BASE FOR WOODLINE FRAMES (PAIR)

For an upright presentation of Woodline frames, made of massive natural beech, incl. screws for fixing.

25882-11 Small

25880-11 Large



ALUMINIUM TUBE

Fixed aluminium tube length 320 mm, Ø 16 mm with threaded bolt M10, to take showcard frames Woodline with internal thread.

15714-91/0320 anodised aluminium

15714-10/0320 black



SUSPENSION RING FOR ALU SNAP-TYPE FRAME

To clamp between rear plate and alu profil, variable in positioning, metal. Suitable for all profile sizes.

21365-00



ACCESSORIES FOR POSTER FRAMES

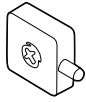

FASTENER FOR WALL

Only suitable for alu profile frames for an invisible fixing to walls, grey. For this application please order alu profile frames "with hole drilling". Depending on size we recommend to use 4 fasteners per frame.

25130-03

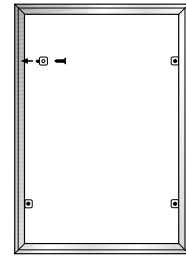

ADHESIVE HOOK

To fix alu profile frames on walls, made of galvanised metal sheet. With adhesive tape for mounting without drilling, for example on glass surfaces, mirror surfaces, etc. Measurements: 30x34 mm. We recommend to use 2 adhesive hooks per frame.

25140-00

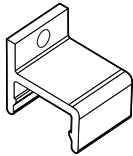

WALL FASTENER

For direct fixing of profile frames series 500 to walls, hole Ø 3,5 mm, transparent.

25180-00

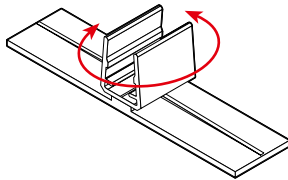

FRAME SUPPORT UPRIGHT

Suitable for profile frames series 500 in an upright position, swivel-type, transparent. We recommend to use this frame support as pair.

25850-00

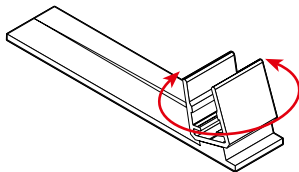

FRAME SUPPORT INCLINED

Suitable for profile frames series 500, 15° inclined, swivel-type, transparent. We recommend to use 2 supports per frame.

25860-00

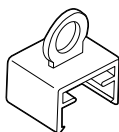

SUSPENSION RING SERIES 500

To suspend poster rails II, III and profile frames series 500, Ø 10 mm, transparent.

25300-00



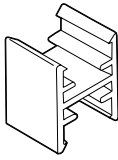

CONNECTING CLIP SERIES 500

To connect profile frames series 500, transparent.

25000-00



CHALK BOARDS

Made of polystyrene, both sides slate coated, for showcard frames of same size, rounded edges, black.

30012-A8/095	A8 (0,95 mm)
30012-A7/095	A7 (0,95 mm)
30012-A6/095	A6 (0,95 mm)
30012-A5/095	A5 (0,95 mm)
30012-A4/095	A4 (0,95 mm)
30012-A3/095	A3 (0,95 mm)
30012-A2/15	A2 (1,5 mm)
30012-A1/15	A1 (1,5 mm)
30012-B2/15	500x700 mm (1,5 mm)
30012-B1/15	700x1000 mm (1,5 mm)



CHALK BOARD A1 HEAT RESISTANT

Chalk board made of heat resistant polycarbonate. Edges 90°, material thickness 1,0 mm, surface black printed.

30012-A1/10/H



HANGING SYSTEMS

Proper hanging with systems

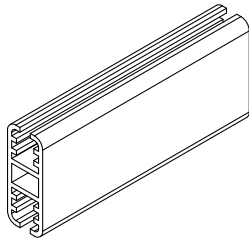

AMBIENTE POSTER RAIL
 Aluminium anodized, profile
 42x17 mm, length 1000 mm.
 50920-91/1000

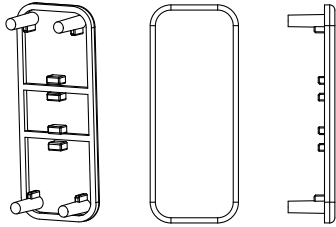

AMBIENTE POSTER RAIL END CAP
 Suits poster rail Ambiente, for a neat
 closing.
 25686-03



AMBIENTE POSTER RAIL BENDED
 Full-circle ring, made from aluminium
 anodized, profile 42x17 mm
 50920-91/R0800 Radius 800 mm
 50920-91/R1250 Radius 1000 mm



FOIL GRIP
 Clip for poster rail Ambiente. For a
 secure hold of foils with a material
 thickness of 0,4 - 0,8 mm.
 25780-03 Foil grip SG, grey
 25785-10 Foil grip XT, black



**AMBIENTE POSTER RAIL BENDED
 CABLE SUSPENSION**
 Suitable for poster rail Ambiente bended. Adjustable wire cable Ø 1,5 mm
 with a slipknot, zinc plated to insert
 sideways into the rail profile. Length
 2000 mm. Other lengths as well as
 cable suspensions for poster rail Ambi-
 ente (straight) upon request.
 25599-00/2000



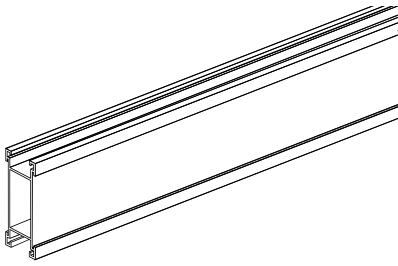

POSTER RAIL II

Anodized aluminium, profil 20x40 mm. Insert for promotional strips with a height 32 mm. Lengths 1000, 2000 and 3000 mm.

15402-90/xxxx

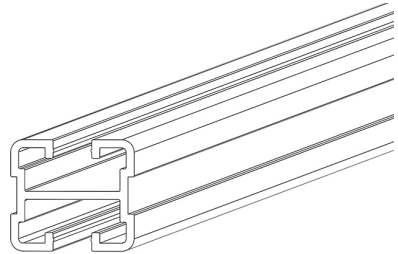

POSTER RAIL III

Anodized aluminium, profil 20x20 mm. Lengths 1000, 2000 and 3000 mm.

15403-90/xxxx

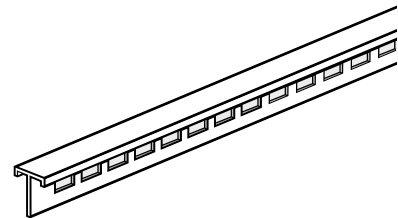

GRIP STRIP ALU RAIL II AND III

For a quick and easy suspension resp. change of frames, poster pockets, etc., transparent.

22570-xxxx

Length 980 mm



HANGER WITH SCREW HOOK

Hanger for alu rail II, consisting of a zinc-plated steel plate (50x14x3 mm with thread M4) and bended screw hook, zinc-plated.

25615-00

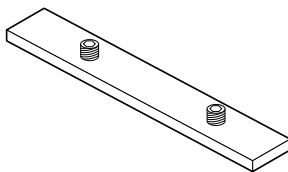

CONNECTOR

To connect alu rails II and III, metal zinc-plated, with two stud screws. With alu rail II we recommend to use two connectors.

25610-00

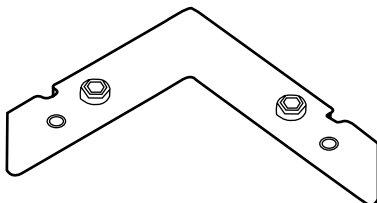

CORNER CONNECTOR 90°

Suits alu rails II and III, to connect two rails with mitred corners, metal zinc-plated, with four stud screws. With alu rail II we recommend to use two connectors.

25620-00

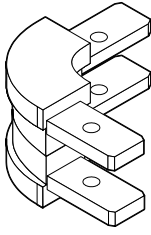

2-PIECE CORNER CONNECTOR

Suits alu rail II, to connect two rails without mitred corners in a 90 ° angle, with screws, grey.

25650-03

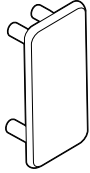

END CAP ALU RAIL II

Suits alu rail II, for a neat closing, grey.

25670-03

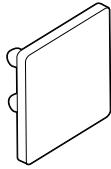

END CAP ALU RAIL III

Suits alu rail III, for a neat closing, grey.

25680-03

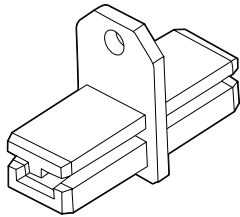

CONNECTOR ALU RAIL III WITH RING

Suits alu rail III, to connect two rails, grey. The integrated eyelet also offers a suspension option.

25630-03

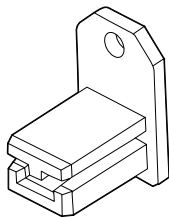

END CAP ALU RAIL III WITH RING

Suits alu rail III, for a neat closing, grey. The integrated eyelet also offers a suspension option.

25735-03

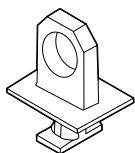

RAIL RING ALU RAILS II AND III

To directly turn into alu rails II and III. Suitable for both - hanging poster rails as well as frames, grey.

25730-03



SUSPENSION RING ALU RAILS II AND III

To suspend alu rails, to insert sideways into the rail profile, transparent.

25700-00

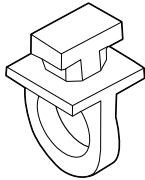

HANGING RING ALU RAILS II AND III

Hanging ring that can be screwed in additionally later, to suspend frames, transparent.

25710-00

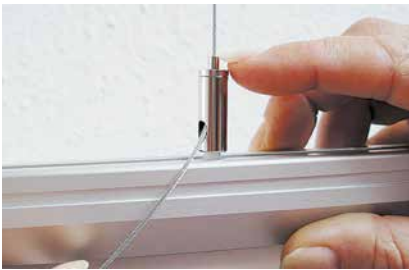

CABLE SUSPENSION

Suitable for alu rails II and III, alu clamp rails 40 and priceboards. Adjustable wire cable Ø 1,2 mm with hook, plate to insert sideways into the rail profile.

- 25696-00/1000 Length 1000 mm
- 25696-00/2000 Length 2000 mm
- 25696-00/3000 Length 3000 mm

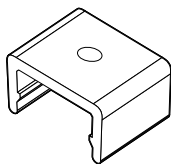

CEILING FASTENER

To mount alu rails II and III or profile frames series 500 directly to the ceiling, hole Ø 3,5 mm, transparent.

25181-00

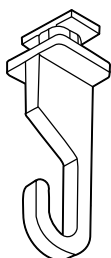
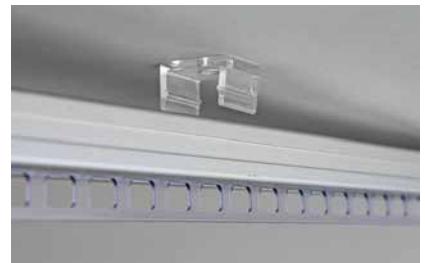

SUSPENSION HOOK ALU RAILS II AND III

To directly screw into the rail profile, to suspend frames and displays, transparent.

25750-00

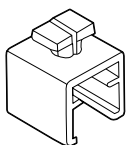

FRAME CLIP ALU RAILS II AND III

Suits alu rails II and III, to directly screw into the rail profile. To suspend frames series 100 with lateral poster insert, transparent.

25740-00



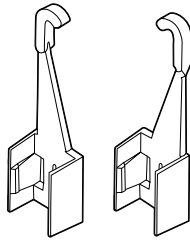

HANGING HOOK ALU RAILS II AND III (PAIR)

To hang directly into the rail profile to suspend frames series 100 with top poster insert, length 54 mm, transparent. Not suitable for laminate- and DEKO frames.

25760-00

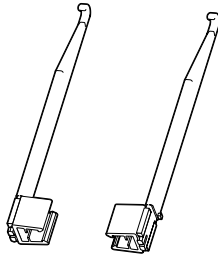

HANGING HOOK LONG ALU RAILS II AND III (PAIR)

Especially long hooks to suspend frames with top sign with up to 100 mm, length 137 mm, transparent.

25770-00



POSTER RAIL ROUND TUBE

Aluminium anodized, tube Ø 20 mm, length 2000 mm.

57810-91/2000



METAL TUBE CONNECTOR POSTER RAIL ROUND TUBE

For a stable connection of round tubes Ø 20 mm, aluminium.

25175-00

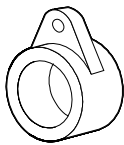

SUSPENSION RING POSTER RAIL ROUND TUBE

To suspend poster rail round tube, grey.

25160-03

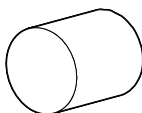

END CAP POSTER RAIL ROUND TUBE

For a neat closing, grey.

25170-03

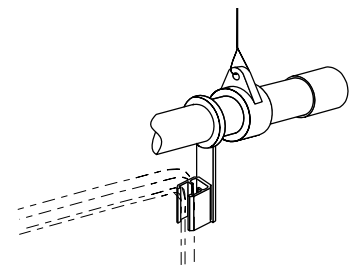

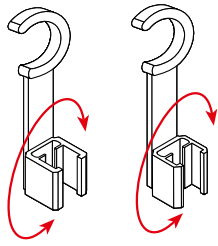

TUBE CLIP, SWIVEL TYPE (PAIR)

To suspend frames from round rails, tubes, etc. clip Ø 22 mm, length 85 mm, transparent.

21610-00 Series 100
22610-00 Series 200

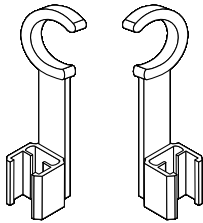

TUBE CLIP SWIVEL TYPE (PAIR) SERIES 500

To suspend alu profile- and Wood-line frames from poster rail round tube, etc., with max. Ø 22 mm, length 85 mm, transparent.

25521-00

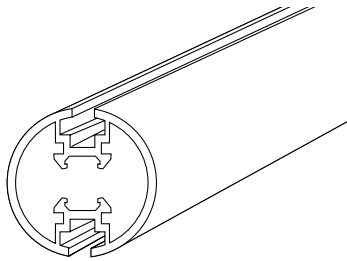

SYSTEM TUBE QUICKPRICE QP

Anodised aluminium, tube Ø 25 mm, length 2000 mm.

15410-90/2000



GRIP STRIP SYSTEM TUBE QUICKPRICE QP

For a quick and easy suspension resp. change of frames, poster pockets, etc., transparent.

22560-00/xxxx Length 990 mm



END CAP SYSTEM TUBE QUICKPRICE QP

Suits system tube quickPrice qP, for a neat closing, grey.

25685-03

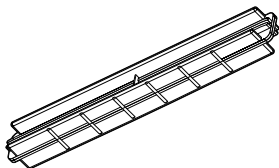

TUBE CONNECTOR SYSTEM TUBE QUICKPRICE QP

To connect system tubes quickPrice qP, length 160 mm, made of plastic, grey.

25603-03



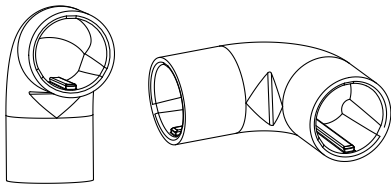

**CORNER CONNECTOR SYSTEM TUBE
QUICKPRICE QP 90°**

To connect system tubes quickPrice qP around the corner, grey.

- 25602-03 Vertical
- 25602-03/W Horizontal



**TUBE CONNECTOR SYSTEM
QUICKPRICE QP WITH RING**

To connect system tubes quickPrice qP, made from metal zinced, with two fixing screws and an integrated ring, length 60 mm.

25606-00



**CABLE SUSPENSION SYSTEM TUBE
QUICKPRICE QP**

Suitable for system tubes quickPrice qP. Adjustable wire cable Ø 1,2 mm with hook, plate to insert sideways into the rail profile.

- 25697-00/1000 Length 1000 mm
- 25697-00/2000 Length 2000 mm
- 25697-00/3000 Length 3000 mm



**SUSPENSION HOOK SYSTEM TUBE
QUICKPRICE QP**

To suspend frames, poster pockets, etc., to slide sideways into rail profile, transparent.

25751-00



**SUSPENSION HOOK SYSTEM TUBE
QUICKPRICE QP**

To suspend frames, poster pockets, etc., to slide sideways into qP tube profile, transparent.

21362-00



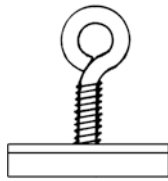

SUSPENSION RING ALU FOR SYSTEM TUBE QUICKPRICE QP

Stable suspension ring Ø 5 mm made of aluminium T-profile, to be inserted into the qP tube profile for a secure fixing.

21363-00

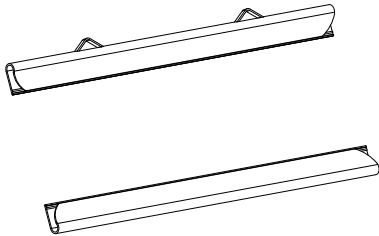

POSTER CLAMP RAIL 15

Clear plastics, profile 15 mm, to insert papers from the side, upper rail with 2 punched rings for suspension, 2-piece set.

- 15440-00/500 Length 500 mm
- 15440-00/600 Length 600 mm
- 15440-00/790 Length 790 mm
- 15440-00/1200 Length 1200 mm

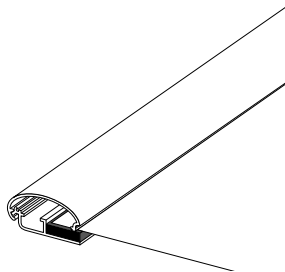

ALU SNAP RAIL 25 MM

Aluminium anodized, profile width 25 mm with snap mechanism for posters with material thickness up to 3 mm. Integrated rubber inlay ensures to clamp secure. Upper rail with two suspension hooks, both rails with grey end caps, 2-piece set.

- 71-50000-91/0500 Length 500 mm
- 71-50000-91/0600 Length 600 mm
- 71-50000-91/0850 Length 850 mm
- 71-50000-91/1000 Length 1000 mm

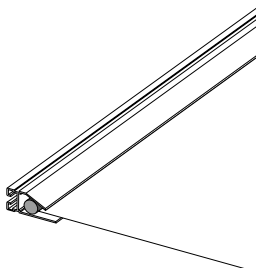

ALU CLAMP RAIL 40 MM

Aluminium anodized, profile width 40 mm. To clamp papers, cartons, etc. with up to 3 mm material thickness.

- 50100-91/0500 Length 500 mm
- 50100-91/1000 Length 1000 mm

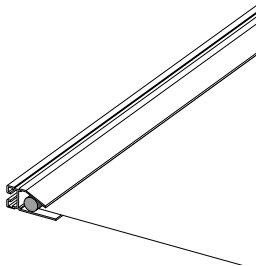

ALU CLAMP RAIL 40 MM WITH ADHESIVE TAPE

Aluminium anodized, profile width 40 mm. To clamp papers, cartons, etc. with up to 3 mm material thickness. With double foam adhesive tape.

- 50110-91/0500 Length 500 mm
- 50110-91/1000 Length 1000 mm



METAL CEILING CLIP

Clip for special Odenwald ceiling grid, to suspend poster rails, priceboards, etc., force up to 18 kgs. Coated metal white. PU: 100 pcs.

20660-01



CADDY CLIP

Clip for special ceiling grid Odenwald, to suspend poster rails, priceboards, etc., force up to 18 kgs, zinc metal. PU: 100 pieces.

20679-00

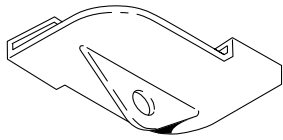

PLASTIC CEILING CLIP

Clip for special Odenwald ceiling grid, to suspend poster rails, priceboards, etc., force up to 4 kgs, plastic white. PU: 100 pcs.

20665-01

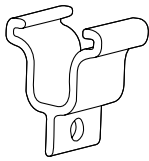

CEILING CLAMP

Clamp with ring Ø 4 mm for special ceiling grid Odenwald, to suspend poster rails, frames or displays with universal hooks, chains, cable suspensions etc., force up to max. 3 kgs. Plastic white. PU: 100 pieces.

20678-01

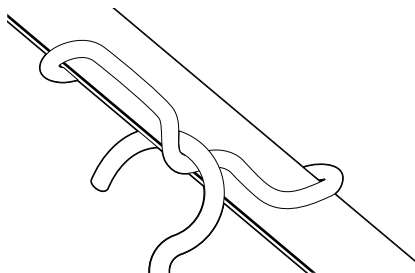

WIRE CEILING CLIP 20

Clip for special Odenwald ceiling grid, to suspend poster rails, poster pockets etc. with hooks and chains. Zinc metal. Force up to max. 2 kgs. PU: 100 pieces.

20674-00



CEILING RING Ø 40 MM

With double adhesive foam tape, white.

20671-01



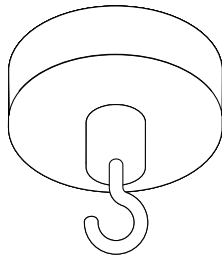

MAGNET FOR CEILING WITH HOOK

To suspend frames, poster pockets, poster rails ect., magnetic force up to approx. 20 kgs (Ø 50 mm) resp. 8 kgs (Ø 32 mm), white.

- 20637-01 Ø 32 mm
- 20635-01 Ø 50 mm

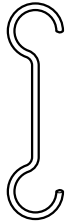

UNIVERSAL HOOK

To suspend poster rails, poster pockets, etc., metal, zincd. PU 50 pcs.

- 24214-00/0100 Length 100 mm (PU 100 pcs.)
- 24214-00/0150 Length 150 mm
- 24214-00/0200 Length 200 mm
- 24214-00/0250 Length 250 mm
- 24214-00/0300 Length 300 mm
- 24214-00/0400 Length 400 mm
- 24214-00/0500 Length 500 mm
- 24214-00/0750 Length 750 mm

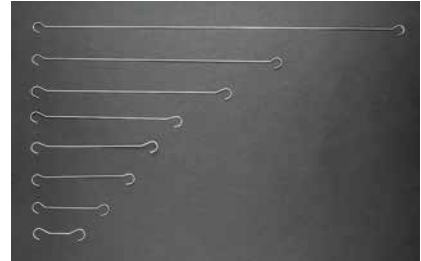

S-HOOK

To suspend poster rails, poster pockets, etc., with knot- or decochains, nickel plated steel. Length 22 mm. PU: 100 pieces.

- 20685-00

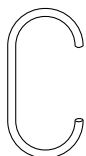

C-HOOK

To suspend poster rails, poster pockets, etc., with knot- or decochains, zincd steel. PU: 100 pieces.

- 20683-00 Length 39 mm
- 20684-00 Length 60 mm

METAL HOOK FOR TUBES

Suitable for tubes Ø 35 mm, to suspend frames, etc., made of zinc coated metal. PU: 50 pcs.

- 25752-00



KNOT CHAIN K16

To suspend poster rails, poster pockets etc. PU roll 30 meters.

20690-00



PRICE CASSETTE FOR BEVERAGES QP 2236

Price cassette with plastic housing colored, 3 single cassette boxes to be opened individually, transparent. Top cassette for posters or wording A5 landscape. Lower cassettes with folded number strips red/black and basic price information. Size: 221x361 mm. Color: white, red.



14362-xx

HANGER QP 2211

Hanger for price cassette qp 2236 for wording (insert size 2/3 A5). Size 221x14 mm. Color: white, red.

14551-xx



DOUBLE CONNECTOR QP

To connect and suspend two price cassettes qp 2236 with hanger qp 2211, transparent.

24860-00



SUSPENSION QP Ø 12 MM

With hook for tubes Ø 12 mm, transparent.

24800-00

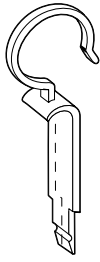

SUSPENSION QP Ø 26 MM

With hook for tubes Ø 26 mm, transparent.

24810-00



SUSPENSION QP WITH LOOP

Suspension unit with loop, transparent.

24820-00

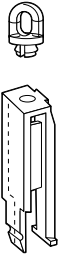

SUSPENSION UNIT QP

To suspend two qP cassettes for beverages (back to back), transparent.

24830-00

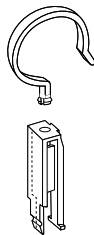

DOUBLE SUSPENSION QP WITH HOOK

To suspend two qP cassettes for beverages (back to back), transparent.

24840-00

POSTER POCKET WITH CROSS BAR

To insert posters A5 landscape and A4 portrait, made of non-reflective PVC 0,4 mm. With punching for fastening by means of clamping hooks Ø 4 mm.

29607-A4A5/04



SUSPENSION COVER WITH HOLES

For a stable and quick suspension of posters, with holes Ø 1 mm. Bent non-reflective PVC 1 mm, transparent, to be used with clamping hooks Ø 4 mm.

29800-A4/10

A4 portrait

29801-A4/10

A4 landscape



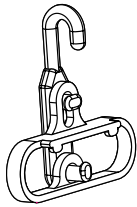

CLAMP HOOK Ø 4 MM

Fixed fitting, to be tightly clipped onto punched displays for beverages, suspension cover, etc. with up to 1 mm thickness, white. Suitable only for precise hole drillings of Ø 4 mm and a distance of 7 mm (distance between display edge and outer line of hole-not in the middle of the punch).



20680-26



CARDBOARD CLAMP 3

To attach onto baskets, boxes, etc. with a material thickness of up to max. 20 mm. Top part is for inserting promotion signs with up to 3 mm thickness, 2-piece transparent. Also suitable for bigger carton signs. We recommend to use 2 clamps per carton sign.



17040-00

CARDBOARD CLAP WITH METAL SPRING

To attach onto crates, wooden boxes, etc. For material thickness 0,5 up to max. 3 mm. Size: 140x60 mm (height x width). Width of spring approx. 15 mm, transparent.

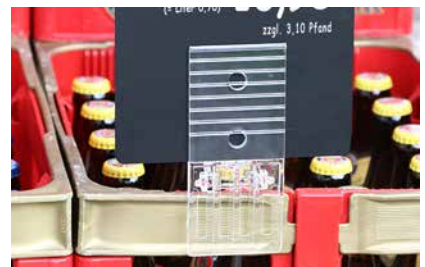

17090-00

POSTER POCKET WITH RINGS

For suspension, made of non-reflective PVC, with rivet metallic rings, nickel plated.

- 29600-A4/03 A4 (0,3 mm)
- 29600-A3/03 A3 (0,3 mm)
- 29600-A2/04 A2 (0,4 mm)
- 29600-A1/04 A1 (0,4 mm)



ACRYLIC DISPLAYS AND STANDS

The current trend in price labelling



DIN A8
52x74 mm



DIN A7
74x105 mm

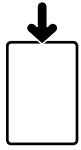

DIN A6
105x148 mm



DIN A6
148x105 mm

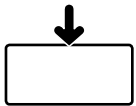

148x70 mm

KLICK ACRYLIC BARKER

An alternative way of providing crystal clear communication between you and your customers. The print is completely covered and protected - without distracting lines or colors. With rear KLICK adaptor to hold our KLICK fixing accessories, transparent.

13580-25	A8
13570-25	A7
13561-25	A6 portrait
13560-25	A6 landscape
13504-25	148x70 mm

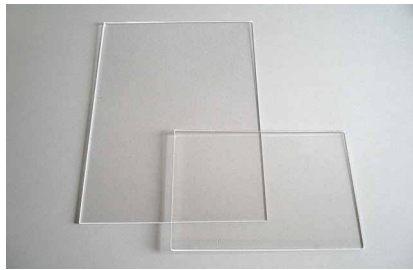

ACRYLIC COVER

Suitable for acrylic holder 150 mm resp. 210 mm, made of 2 mm bent acrylic, total thickness 4 mm, transparent.

27100-A5/20	A5 portrait
27101-A5/20	A5 landscape
27100-A4/20	A4 portrait
27101-A4/20	A4 landscape

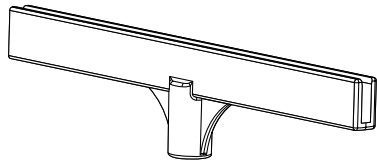

HOLDER FOR ACRYLIC COVER

Suits tubes Ø 10 mm, to hold acrylic pockets incl. inlay with a max. thickness between 3,8-4,3 mm, transparent.

20060-00	Holder 210 mm
20061-00	Holder 150 mm

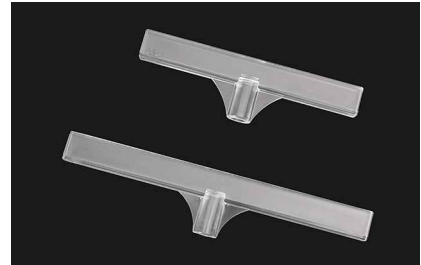

CARDBOARD CLAMP 20 FOR ACRYLIC COVER

Suitable for acrylic covers with 3,5 - 4,5 mm thickness. To clamp onto baskets, boxes, trays with max. 20 mm thickness, transparent. We recommend to use 2 clamps per acrylic cover.

24715-00





SUSPENSION COVER WITH HOLES

For a stiff and easy suspension, along with fitting clamp hooks Ø 4 mm, made of bent, non-reflective PVC 1 mm, with hole drilling Ø 1mm, transparent.

- 29800-A4/10 A4 portrait
- 29801-A4/10 A4 landscape

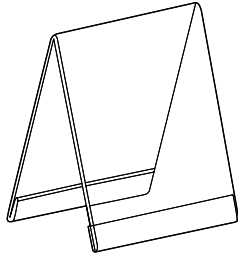

ACRYLIC STAND A

Bent acrylic part in A-shape, 3 fold bent, thickness 2 mm, transparent. For poster inserts with max. 150 g/sqm.

- 27500-A7/20 A7 portrait
- 27501-A7/20 A7 landscape
- 27500-A6/20 A6 portrait
- 27501-A6/20 A6 landscape

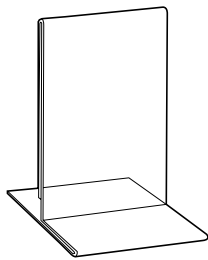

ACRYLIC STAND T

Bent acrylic part in T-shape, 3 fold bent, thickness 2 mm, transparent. For 2 poster inserts with max. 150 g/sqm.

- 27400-A6/20 A6 portrait
- 27400-A5/20 A5 portrait
- 27400-A4/20 A4 portrait
- 27400-0005/20 approx. 210x105 mm

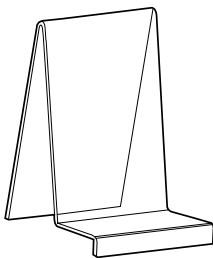

BOOK SUPPORT

Bent acrylic part in an A-shape, 3-fold bent, thickness 3 mm, with presentation stair (25 mm depth) for books, perfumes, etc.. Size: 100x110 mm, transparent.

- 27600-0001/30

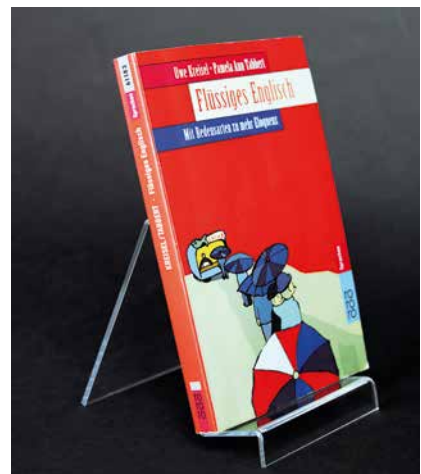



ACRYLIC STAND STEEL ARC

Arch holder 180x70 mm, made of brushed stainless steel, with insert slit 4,5 mm wide and max. insert depth of 14 mm, incl. bent acrylic cover.

- 27800-A5/20 A5 portrait
- 27800-A4/20 A4 portrait

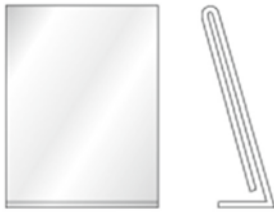
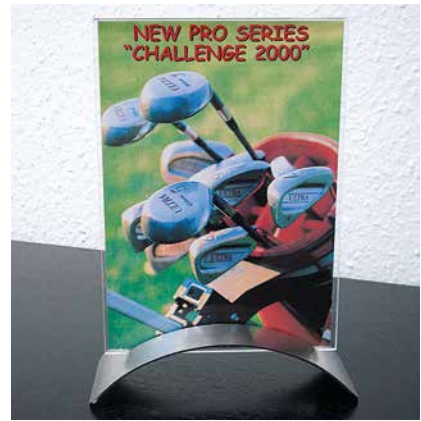

ACRYLIC STAND L

Inclined bent acrylic part in a L-shape, 2 fold bent, thickness 2 mm, transparent.

- 27300-A7/20 A7 portrait
- 27301-A7/20 A7 landscape
- 27300-A6/20 A6 portrait
- 27301-A6/20 A6 landscape
- 27300-A5/20 A5 portrait
- 27301-A5/20 A5 landscape
- 27300-A4/20 A4 portrait
- 27301-A4/20 A4 landscape
- 27300-A3/30 A3 portrait (3 mm)
- 27301-A3/30 A3 landscape (3 mm)



ACRYLIC HOLDER WITH ALU SNAP RAIL

Inclined bent acrylic part in a L-shape, 2 fold bent, thickness 2 mm, size A4, transparent. With alu snap rail 25 mm, length 210 mm, anodized. End caps, grey.

- 27308-A4/20



LEAFLET BOX T

For an inclined presentation of brochures on desks and counters. Depth 31 mm, transparent.

- 32014-00/31 A4 portrait
- 32015-00/31 A5 portrait
- 32019-00/31 approx. 210x105 mm



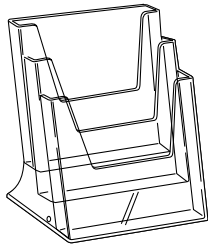

LEAFLET BOX T 3-FOLD

For an inclined presentation of several brochures behind each other on desks and counters. Depth 105 mm total, transparent.

- 32034-00/105 A4 portrait
- 32035-00/105 A5 portrait
- 32039-00/105 approx. 210x105 mm

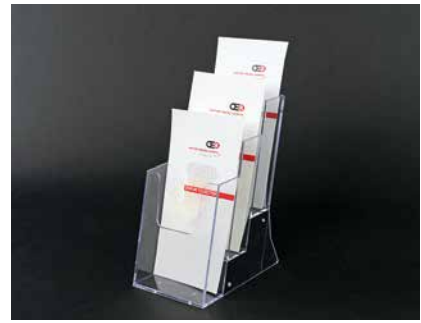

BOX FOR BUSINESS CARDS T, TRIBLE

To be placed on desks and counters, transparent. Size: 95x54x19 mm (landscape).

32013-00/13

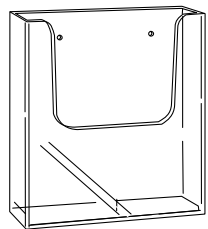

LEAFLET BOX W

For wall-mounting, with 2 holes, transparent. Depth 35 mm.

- 32114-00/35 A4 portrait
- 32115-00/35 A5 portrait
- 32119-00/35 approx. 210x105 mm



POSTER POCKET WITH METAL RINGS

For suspension, made of bent, non-reflective PVC, with rivet metal rings, nickel plated.

- 29600-A4/03 A4 (0,3 mm)
- 29600-A3/03 A3 (0,3 mm)
- 29600-A2/04 A2 (0,4 mm)
- 29600-A1/04 A1 (0,4 mm)





PRICE TAG POCKET

Made of welded glossy, soft PVC 0,2mm, with 1 center hole, portrait, transparent. PU 100 pcs.

- 29850-A8/02 A8
- 29850-A7/02 A7
- 29850-A6/02 A6
- 29850-A5/02 A5
- 29850-A4/02 A4 (with 2 holes)



FASTENER FOR PRICE TAG POCKET

For fixing the price tag pockets to furniture, tools, textiles, white. PU 1000 pcs.

- 24900-00



L-SUPPORT CHALKBOARD

Made of PS 2,0 mm, slate coated, mat black, portrait.

- 30302-A4/20 A4
- 30302-A5/20 A5
- 30302-A6/20 A6



CHECKOUT EQUIPMENT

Sales promotion in the checkout area

CHECKOUT EQUIPMENT



CHECKOUT DIVIDER 30X30 MM RED

For inlays, promotion strips with size 309x23 mm, incl. 2 end caps, red and 3 PVC strips, transparent. Overlaying round edges protect the divider from getting scratched. Length 310 mm.

37010-06/310

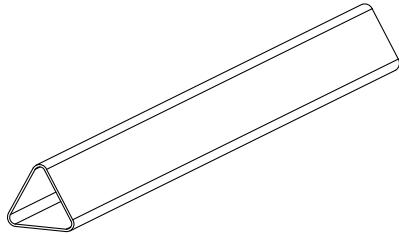

CHECKOUT DIVIDER 30X30 MM TRANSPARENT

Advertising by inserts. Length 310 mm. End caps to be ordered separately.

88-37000-00/300

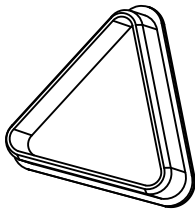

END CAP FOR CHECKOUT DIVIDER 30X30 MM TRANSPARENT

To be put and glued at the ends of sideways into the checkout divider. Colors: white, rape yellow, red, black.

84-15499-xx



END CAP LARGE FOR CHECKOUT DIVIDER 30X30 MM TRANSPARENT

To be put outside onto the divider (and resp. to be glued). Divider is laying only on the edges of the end caps. Advantage: divider does not get scratched. Colors: white, traffic red.

84-15497-xx



CHECKOUT DIVIDER WOOD

Made of pure oak. Size: 30x30x300 mm. Branding upon request.

37021-00 rectangular
37020-00 triangular



CHECKOUT DIVIDER T

Made of solid wood natural beech with T-profile slot and 3 super-grips (to be inserted sideways). Incl. transparent PVC poster protector 297x140x0,5 mm.

37030-00





CASH TRAY WOOD

Made from pure oak in concave square style. With rubber stoppers for a non-slip stand. Size: 140x140x20 mm. Branding upon request.

13289-00



CASH TRAY K 215X100 MM

Made from 2 mm acrylic, bent, transparent. With rubber stoppers for a non-slip stand. Insert upon request. (Bottom size max. 96x215 mm - complete size max. 190x215 mm).

13288-00



CASH TRAY K 210X175 MM

Made from unbreakable plastics, transparent, with rounded corners. With rubber stoppers for a non-slip stand,. Insert upon request (size 153x153 mm).

13281-00



CASH TRAY GLASS

With rounded corners, round cash hollow, transparent. With rubber stoppers for a non-slip stand. Size: 150x150 mm. Insert upon request.

13285-00



CASH TRAY K 180X180 MM

Made from unbreakable plastics, in concave shape, transparent. With rubber stoppers for a non-slip stand,. Insert upon request (size 150x135 mm).

13290-00





INFOLINE W A4

For wall fixing, with 5 or 10 Frames in OEK standard colors, transparent or multicolored (= color code -00), incl. non-reflective PVC pockets, plastic rear black (for 10 frames with metallic rear in grey), total height: 330 mm.

- 39640-xx/5 With 5 Frames, with metal support plate
- 39640-xx/10 With 10 Frames, with plastic rear



INFOLINE W A3

For wall fixing, with 5 frames in OEK standard colors, transparent or multicolored (= color code -00), incl. non-reflective PVC pockets. Rear with two plastic profile holders, black and aluminium connector.

- 39630-xx/5



INFOLINE T

With 7 or 10 Infoline frames DIN A4 in OEK standard colors, transparent or multicolored (= color code -00), incl. non-reflective PVC pockets. Metal L-shaped stand, anthracite gray. Total height: 350 mm.

- 39200-xx/7 With 7 frames
- 39200-xx/10 With 10 frames

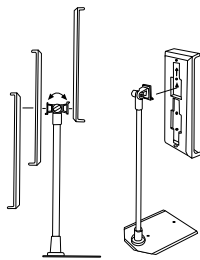

INFOLINE 401

With 5 or 10 Infoline frames DIN A4 in OEK standard colors, transparent or multicolored (= color code -00), incl. non-reflective PVC pockets, SK base black, fixed aluminium tube 380 mm, 1 hinge with locking screw on the back.

- 39445-xx/5 With 5 frames
- 39445-xx/10 With 10 frames



INFOLINE 400A

With 5 or 10 Infoline frames DIN A4 in OEK standard colors, transparent or multicolored (= color code -00), incl. non-reflective PVC pockets, SK base black, adjustable aluminium tube 400 - 700 mm, 1 hinge at the back.

- 39405-xx/5 With 5 frames
- 39405-xx/10 With 10 frames



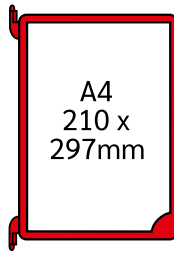

INFOLINE FRAME A4

With molded lock brackets and edge for easy grip, suitable for Infoline stands, in OEK standard colors and transparent.

11406-xx

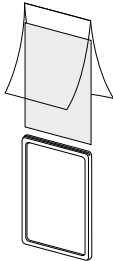

PVC POCKETS

Suitable for showcard frames of same size, folded short side, non-reflective PVC, transparent.

- 29100-A5/02 DIN A5 (0,2 mm)
- 29100-A4/02 DIN A4 (0,2 mm)
- 29100-A3/03 DIN A3 (0,3 mm)

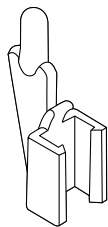

BROWSER CLIP

For mounting of showcard frames series 100, to be used in Infoline models, transparent.

21880-00



POSTERLINE STAND

Stable metallic stand, powder coated grey, with 10 frames DIN A1 in OEK standard colors, transparent or multicolored (= color code -00), incl. non-reflective PVC pockets and extra lock brackets. Dimensions approx.: 600/1600/660 mm (W/H/D). Delivered for self-assembly.

39871-xx



POSTERLINE WALL

With 10 frames in OEK standard colors, transparent or multicolored (= color code -00), incl. Non-reflective PVC pockets and lock brackets. Metallic rear plate, 2-parts, grey. Delivered for self-assembly.

- 39891-xx DIN A1
- 39892-xx DIN A2



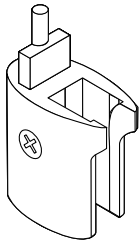

LOCK BRACKETS WITH METAL-PIVOT

Very stable, screwed version with metal-pivot, for frames series 200 to be used in Infoline models, transparent.

22890-00

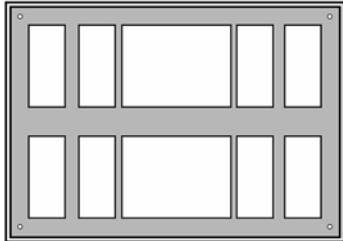

BASKET DISPLAY FOR SHOPPING TROLLEYS - DIN A4 (PAIR)

To be attached on the shopping trolley by plastic clips, with drain slots for rain water. For posters with up to 1,8 mm thickness. Colors: black, traffic red. Mounting with screws not included available upon request.

18040-xx

PVC PROTECTION

Suitable for showcard frames of same size, non-reflective PVC, transparent.

29000-A4/02 A4 (0,2 mm)



SHOWCARD FRAME FOR SHOPPING TROLLEYS - LSE

Made of high-grade unbreakable plastics, specially designed for attachment (outside or inside) onto shopping trolleys, fixing set to be ordered separately. Colour: red. Measurements: 252x195 mm.

11405-06





FIXING SET FOR FRAMES SERIES 100

For attachment of standard showcard frames (series 100) onto shopping trolleys, 4-parts set, transparent.

21432-00



PVC POCKET 252X195 MM

Suits showcard frame 252x195mm for shopping trolleys, non-reflective PVC, folded long side, thickness 0,3 mm, transparent.

29101-0005/03

SHOPPING BASKET

Made of plastic in red, 1 handle black, volume 20 litres, measurements: 300x230x430 mm (W/H/D). Further colors and logo print upon request.

18055-xx

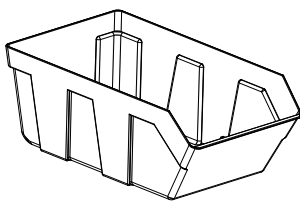

CONTAINER 11 L

Measurements: 246x410x150 mm, Volume approx. 11 litres, transparent. Stackable in each other.

80463-00

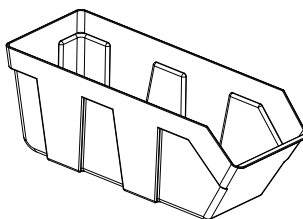
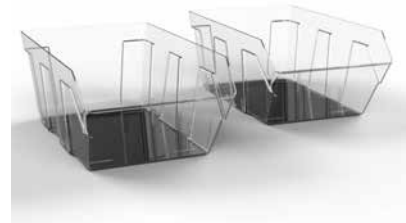

CONTAINER 7 L

Measurements: 146x410x150 mm, Volume approx. 7 litres, transparent. Stackable in each other.

80462-00



SHELF STOPPERS AND WOBBLERS

Guaranteed attention for your products

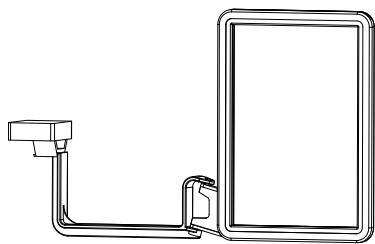

SHOPPER STOPPER WITH SWIVEL FRAME A6 LANDSCAPE

For fixing onto metal shelvings, magnetic force up to 5,6 kgs, due to gravity the frame swivels back 90° to the shelf, swivel arm length 65 mm or 85 mm and magnet in white. Frame colors: white, grey, red.

- 33956-xx length 65 mm
- 33957-xx length 85 mm

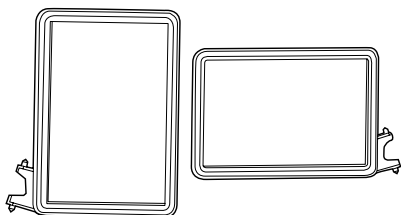

SWIVEL FRAME A6

Frame always swivels in 90° position to the shelf due to gravity, to be mounted with swivel arm and different fixing accessories. Colors: white, grey, red.

- 16666-xx portrait
- 16656-xx landscape



SWIVEL ARM

Connecting element between swivel frame and fixing accessories, white.

- 26070-01 Short length 65 mm
- 26071-01 Long length 95 mm

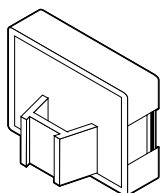

RS-MAGNET

Magnetic holder 32x38 mm, to hold swivel arm, magnetic force up to 5,6 kg, white.

- 26230-01

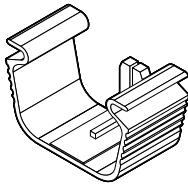

CLIP FOR WIRE BASKETS

For wire baskets and shelves, suitable for wires with a distance of up to 40 mm, wire Ø 2 - 5 mm, white.

26040-26



SHOPPER STOPPER KLICK

With klick adaptor, to suit all fastening elements of the Klick accessories, transparent.

17441-00

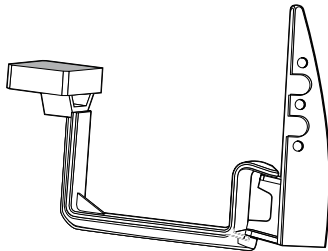

SHOPPER STOPPER SWIVEL-ARM WITH MAGNET

For use on metal shelving, to clamp special poster pocket 200x200 mm. Set consisting of white square magnet, magnetic force up to 5,6 kgs, swivel-arm length 85 mm and shopper stopper, transparent.

28005-00/01

POSTER POCKET 200X200 MM

To be used with shopper stoppers described above, with 3 clamp holes for a secure and tight fit, made of non-reflecting PVC, transparent.

29600-0007/04

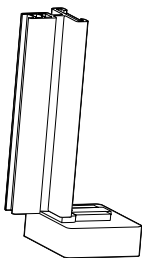

SHOPPER STOPPER SUPERGRIP WITH MAGNET

Square magnetic fastener, magnetic force up to 5,6 kgs with Klick adaptor white and display holder 75 mm transparent, to insert and hold signs and cards with 0,4 - 2 mm thickness.

17421-00



BANNER HANGER WITH MAGNETIC BASE

Magnetic base white 60x35 mm with hinge, alu tube Ø 10 mm, length 250 resp. 400 mm with end cap white. Suspension accessories to be ordered separately.

- 26570-01/0250 Length 250 mm
- 26570-01/0400 Length 400 mm



BENT BANNER HANGER WITH MAGNETIC BASE

Magnetic base white 60x35 mm with hinge, bent alu tube Ø 10 mm (height 70 mm), length 250 with end cap white. Suspension accessories to be ordered separately.

- 26572-01/0250



BANNER HANGER FOR TEGO UP-RIGHTS

Zinc-plated metal hook for Tego up-rights with alu tube Ø 10 mm, adjustable 400-750 mm, tube fixing grey, end cap white. Suspension accessories to be ordered separately.

- 26580-00/-0750



BANNER HANGER FOR SHELF UP-RIGHTS

Adjustable clamp made of zinc coated metal, suitable for different shelf up-rights with rectangular slots, alu tube Ø 10 mm adjustable 400-750 mm, tube fixing grey, end cap white. Suspension accessories to be ordered separately.

- 26585-00/-0750



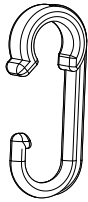

TUBE HOOK FIXED

For a secure and tight suspension of punched poster pockets, banners etc. for tubes Ø 10 mm, transparent.

21340-00/D10

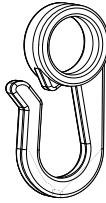

TUBE HOOK RING

With ring Ø 10 mm for suspension of punched poster pockets, banners, ect., transparent.

21355-00/D10

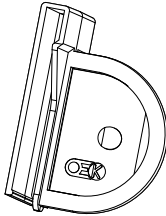

SHOPPER STOPPER HR

To insert into scanner rails, for punched crowners and signs with a material up to 1 mm thickness, transparent. Punching at 10 mm.

17403-00

Height 39 mm

17404-00

Height 53 mm

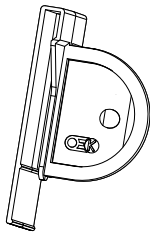

SHOPPER STOPPER ME

To insert into scanner rails, for punched crowners and signs with a material up to 1 mm thickness, transparent. Punching at 12 mm.

17405-00

Height 39 mm

17406-00

Height 53 mm



SPRING CLIP

To be fixed onto scanner rails 39 mm, to take cards with a material thickness of max. 0,2 - 0,6 mm, polished stainless steel.

28050-00

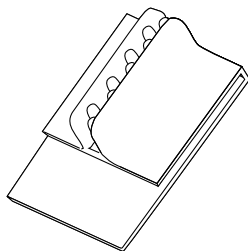

SHOPPER STOPPER SC

To be fixed onto scanner rails 39 mm, to take cards with a material thickness of max. 0,3 - 0,6 mm, transparent.

17400-00



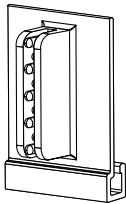

SHOPPER STOPPER B

To clip on from underneath onto different scanner rails, to hold cards with a material thickness of max. 0,3 - 0,6 mm, transparent.

17402-00

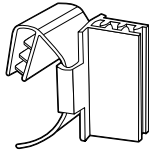

FLEXIBLE SHOPPER STOPPER SUPERGRIP

To clip onto scanner rails, sign holder adjustable in 90° angle, to hold cards, crownlets, etc. with a material thickness of max. 0,4 - 2 mm, transparent. PU: 100 pcs.

28011-00



SHOPPER STOPPER SUPERGRIP

To clip onto scanner rails, to hold cards, crownlets, etc. with a material thickness of max. 0,4 - 2 mm, transparent. PU: 100 pcs.

28010-00/20



UNIVERSAL SIGN HOLDER

To be fixed to Tego-holms or for a universal fixing with screws. Material: polished zinc-coated steel. Length approx. 350 mm, adjustable up to 600 mm. Front with welded plate and flexible display holder 75 mm for a material thickness of 0,4 - 2 mm. Available upon request.

26686-91/-600



PETG-FLAGPOLE

Bent holder made of PETG, 1,0 mm. Size (WxHxD) approx. 80x31x12 mm. To suspend flags, banners etc. from banner hangers and tubes with Ø 10 mm. Oscillation by gravity, incl. screw and rubber ring, black as sliding prevention.

21345-00



INDEX OF ARTICLES

11300-xx	Standard	6	20271-03	Hinge for Base	48
11308-xx	Laminate	6	20300-xx	Base N	46
11330-G-xx	Greenline	7	20310-03/03	Base BK	46
11330-xx	Dekoline	6	20320-10	Base SK	46
11400-xx	Standard	6	20325-xx	Base SK ECO	47
11405-06	Showcard Frame for Shopping Trolleys - LSE	7, 84	20330-xx	Base BD	47
11406-xx	Infoline Frame A4	83	20340-99/xx	Base K round	45
11408-xx	Laminate	6	20340-xx	Base L	45
11420-G-xx	Greenline	7	20348-xx	Base K ECO	44
11420-xx	Dekoline	6	20350-G-xx	Base K Greenline	46
11445-xx	Showcard Frame cross bar	7	20350-xx	Base K	45
11500-xx	Standard	6	20352-03	Base RS 200x90	45
11508-xx	Laminate	6	20360-xx	Base KB	46
11520-G-xx	Greenline	7	20370-03	Magnetic base MF4	36
11520-xx	Dekoline	6	20372-03	Magnetic base MF2	47
11600-xx	Standard	6	20373-03	Magnetic base MF with hinge	48
11840-xx	Showcard Frame 297 x 297 mm	7	20375-03	Magnetic base Ø 50 mm with tube holder	48
11855-xx	Showcard Frame 140 x 417 mm	7	20377-01	Magnetic fastener square swivel type	36
12100-xx	Standard	6	20378-xx	Magnetic base 60x38 with hinge	48
13281-00	Cash tray K 210x175 mm	81	20380-xx	Base KL	45
13285-00	Cash tray Glass	81	20390-xx	Base RS	45
13288-00	Cash tray K 215x100 mm	81	20400-xx	Base NT	46
13289-00	Cash tray wood	81	20480-00	Table Stand Big Cube	19
13290-00	Cash tray K 180x180 mm	81	20482-00	Table Stand Rectangular	19
13504-25	Klick acrylic barker	74	20483-00	Table Stand Arch 1/4	19
14362-xx	Price cassette for beverages QP 2236	70	20485-00	Table Stand Arch 1/2	19
14551-xx	Hanger QP 2211	70	20491-00/A	Wooden stepped base	19
15310-00	Showcard Frame Woodline	17	20495-00/A3	Wooden base for woodline frames	18
15380-00/A3	Woodline Frame	17	20530-00	KS 1 Oval tube clip	43
15402-90/xxxx	Poster Rail II	61	20531-00	KS 1 A Flat oval tube clip	43
15403-90/xxxx	Poster Rail III	61	20532-10/160	KS 2 R Clamp for round tube	44
15410-90/xxx	System tube quickPrice QP	65	20533-10/160	KS 2 O Clamp for oval tube	44
15410-90/xxx	Poster clamp rail 15	67	20534-00	KS 3 Oval tube clip	43
15710-xx/0320	Dekoline Tube	51	20545-03	Showcard holder DK (Pair)	49
15712-xx/0320	Twinset Tube	51	20560-xx	Clamp Allrounder	41
15714-xx/0320	Aluminium Tube	55	20571-00	Universal clamp 25	41
15736-91/-1900/10	Aluminium Tube BD	51	20580-xx	Display clamp to hold tubes Ø 12 mm	41
15800-91/03/-xxxx	Adjustable Aluminium Tube	50	20601-00	Magnetic ring rectangular	34
16656-xx	Swivel frame A6	88	20602-01	Magnetic ring square	34
17040-00	Cardboard clamp 3	72	20635-01	Magnet for ceiling with hook	69
17050-00	Clampholder for Tube	54	20660-01	Metal ceiling clip	68
17090-00	Cardboard clap with Metal Spring	72	20665-01	Plastic ceiling clip	68
17400-00	Shopper stopper SC	91	20671-01	Ceiling ring Ø 40 mm	68
17402-00	Shopper stopper B	92	20674-00	Wire ceiling clip 20	68
17403-00	Shopper stopper HR	91	20678-01	Ceiling clamp	68
17405-00	Shopper stopper ME	91	20679-00	Caddy clip	68
17421-00	Shopper stopper Supergrip with magnet	89	20680-26	Clamp hook Ø 4 mm	72
17441-00	Shopper stopper Klick	89	20683-00	C-Hook	69
18040-xx	Basket Display for Shopping Trolleys - DIN A4 (Pair)	84	20685-00	S-Hook	69
18055-xx	Shopping Basket	85	20690-00	Knot chain K16	70
18060-7016	Twinset Basic Frame DIN A4 landscape	6	21000-00	Frame connector	33
18696-00	Pavement Support Woodline Outdoor	20	21010-00	Frame connector swivel type	33
20010-xx	T-Piece 60 mm series 100 Ø 10 mm	52	21020-00	Frame connector Portrait	34
20011-G-xx	T-Piece Greenline	52	21030-00	Frame connector S100/200	34
20011-xx	T-Piece 90 mm series 100 Ø 10 mm	52	21040-00	Square hanger	41
20011-xx/09	T-Piece 90 mm series 100 Ø 9 mm	52	21060-00	Adaptor parallel klick	42
20012-xx	T-Piece 160 mm Ø 10 mm	52	21070-00	Adaptor 90° klick	42
20025-00	Bottle Holder	42	21110-26	Flexible clip with G-Clamp	38
20030-7016	Base Plinth for Twin-Set Basic Frame	53	21119-26	Flexible clip with adhesive	39
20050-xx	T-Piece series 500	53	21120-00	Fastener with rotary clip	40
20060-00	Holder for acrylic cover	53, 74	21130-00	Wall fastener series 100	39
20090-xx	U-Frame DIN A4 landscape	7	21180-00	Keyhole fastener	39
20100-35/xxxx	Chrome Tube	49	21200-xx	Magnetic fastener round	34
20140-35/xxxx	Adjustable chrome tube	50	21219-00	Magnetic fastener rectangular parallel	35
20144-03/xxxx	Adjustable chrome tube with lever clamp	50	21220-00	Magnetic fastener rectangular swivel type	35
20160-10/-xxxx	Adjustable plastic tube for T-piece Ø 9 mm	50	21230-01	Magnetic fastener square parallel	35
20160-10/-xxxx	Adjustable plastic tube for T-piece Ø 10 mm	50	21231-00	Adaptor parallel	36
20167-01/xx	Plastic Tube NT	51	21240-01	Magnetic fastener square without adaptor	35
20170-00	MF Connector	48	21250-01	Magnetic fastener square 90°	35
20176-xx	Chrome Tube BD	51	21251-00	Adaptor 90°	36
20200-xx	SB Tube Holder for tubes Ø 12 mm	47	21255-01	Magnetic tube clip	36
20269-03	Hinge for T-Piece	52	21260-xx	Magnetic fastener rectangular 90°	35
			21300-00	Suspension ring 90°	31

INDEX OF ARTICLES

21310-00	Suspension ring parallel	31	24800-00	Suspension qP Ø 12 mm	70
21315-00	Suspension ring swivel type	31	24810-00	Suspension qP Ø 26 mm	71
21320-00	Suspension hook short	31	24820-00	Suspension qp with loop	71
21325-00	Suspension hook wire swivel type (pair)	33	24830-00	Suspension unit qP	71
21330-00	Hanging hook short swivel type (pair)	33	24840-00	Double suspension qP with hook	71
21331-00	Hanging hook big swivel type (pair)	33	24860-00	Double connector qP	70
21340-00/D10	Tube Hook fixed	91	24900-00	Fastener for price tag pocket	78
21345-00	PETG-Flagpole	92	25000-00	Connecting Clip Series 500	57
21355-00/D10	Tube Hook Ring	91	25130-03	Fastener for Wall	56
21360-00	Suspension hook short (pair)	32	25140-00	Adhesive Hook	56
21361-00	Suspension ring sideways	31	25160-03	Suspension ring poster rail round tube	64
21362-00	Suspension hook system tube Quickprice qP	66	25170-03	End cap poster rail round tube	64
21363-00	Suspension ring alu for system tube Quickprice qP	67	25175-00	Metal tube connector poster rail round tube	64
21365-00	Suspension ring for alu snap-type frame	55	25180-00	Wall Fastener	56
21370-00	Suspension hook (pair)	31	25181-00	Ceiling fastener	55, 63
21400-00	Hanging hook	32	25300-00	Suspension Ring Series 500	56
21410-03	Suspension hook 2-part (pair)	32	25521-00	Tube clip swivel type (pair) series 500	55, 65
21430-00	Fastening clip for wires (pair)	32	25602-03	Corner connector system tube Quickprice qP 90°	66
21431-00	Wire hooks (pair)	32	25603-03	Tube connector system tube Quickprice qP	65
21432-00	Fixing set for frames series 100	85	25606-00	Tube connector system Quickprice qP with ring	66
21450-00-E	Mounting set magnet Ø 50 mm	48	25610-00	Connector	61
21508-xx	Tube clips (series 100)	38	25615-00	Hanger with screw hook	61
21610-00	Tube clip swivel-type (pair)	33, 65	25620-00	Corner connector 90°	61
21660-01/xxxx	C-rail	42	25630-03	Connector alu rail III with ring	62
21663-00	Fastener 90° for C-rail	42	25650-03	2-Piece Corner Connector	62
21665-00	Fastener parallel for C-rail	43	25670-03	End cap alu rail II	62
21706-00	Suction pad	37	25680-03	End cap alu rail III	62
21715-00	Cardboard clamp 20	40	25685-03	End cap system tube Quickprice qP	65
21720-03	Pegboard hook with tube holder	40	25686-03	Ambiente Poster Rail End Cap	60
21740-00	Tube Clamp	43	25695-00/1000	Cable Suspension for LED snap frame (pair)	21
21750-00	RA1 Frame base support	37	25696-00/xxxx	Cable suspension	63
21750-G-xx	Frame base support Greenline	38	25697-00/xxxx	Cable suspension system tube Quickprice qP	66
21760-00	RA2 Frame base support	37	25599-00/2000	Ambiente Poster Rail Bended Cable Suspension	60
21760-G-xx	Frame base support Greenline	38	25700-00	Suspension ring alu rails II and III	63
21880-00	Browser Clip	83	25710-00	Hanging ring alu rails II and III	63
21920-00	Promotion card clip	34	25730-03	Rail ring alu rails II and III	62
21940-00	Retaining clip	37	25735-03	End cap alu rail III with ring	62
22000-00	Frame connector	33	25740-00	Frame clip alu rails II and III	55, 63
22010-00	Frame connector swivel type	33	25750-00	Suspension hook alu rails II and III	63
22040-00	Hinged hanger	42	25751-00	Suspension hook system tube quickprice qP	66
22120-00	Fastener with rotary clip	40	25752-00	Metal hook for tubes	69
22132-00	Wall fastener square series 200	39	25760-00	Hanging hook alu rails II and III (pair)	64
22140-00	Wall fastener rectangular series 200	39	25770-00	Hanging hook long alu rails II and III (pair)	64
22220-00	Magnetic fastener rectangular swivel type	35	25780-03	Foil grip	60
22230-01	Magnetic fastener square parallel	35	25850-00	Frame support upright	56
22231-00	Adaptor parallel	36	25860-00	Frame support inclined	56
22250-01	Magnetic fastener square 90°	35	25880-11	Wooden Base for woodline frames (pair)	17, 55
22251-00	Adaptor 90°	36	26040-26	Clip for wire baskets	89
22300-00	Suspension ring 90°	31	26070-01	Swivel arm	88
22310-00	Suspension ring parallel	31	26230-01	RS-Magnet	88
22315-00	Suspension ring swivel type	31	26570-01/xxxx	Banner hanger with magnetic base	90
22320-00	Suspension hook short	31	26572-01/0250	Bent Banner hanger with magnetic base	90
22330-00	Hanging hook big swivel type (pair)	33	26580-00/-0750	Banner hanger for Tego uprights	90
22350-00	Hanging hook short swivel type (pair)	33	26585-00/-0750	Banner hanger for shelf uprights	90
22370-00	Suspension hook (pair)	31	26686-91/-600	Universal Sign Holder	92
22371-00	Suspension hook (F2-long)	32	27100-xx/20	Acrylic Pocket	53, 74
22512-00	Tube clips (series 200)	38	27300-A3/30	Acrylic stand L	76
22560-00/xxxx	Grip strip system tube Quickprice qP	65	27308-A4/20	Acrylic holder with alu snap rail	76
22570-xxxx	Grip strip alu rail II and III	61	27400-0005/20	Acrylic stand T	75
22610-00	Tube clip swivel-type (pair)	33, 65	27500-xx/20	Acrylic stand A	75
22705-00	Suction pad parallel	37	27600-0001/30	Book support	75
22750-00	RA1 Frame base support	37	27800-xx/20	Acrylic stand Steel Arc	76
22760-00	RA2 Frame base support	37	28005-00/01	Shopper Stopper Swivel-Arm with Magnet	89
22890-00	Lock Brackets with Metal-Pivot	84	28010-00/20	Shopper stopper supergrip	92
22920-00	Promotion card clip	34	28011-00	Flexible shopper stopper supergrip	92
22940-00	Retaining clip	37	28050-00	Spring clip	91
24214-00/xxxx	Universal hook	69	29000-xx/02	PVC Protective Covers	8, 54, 84
24280-01	Chalk board marker (water soluble)	20	29010-0010/05	PVC Protective Cover DIN A1 Plus	11
24282-01	Chalk board marker (water resistant)	20	29010-xx/05	PVC Protective Covers	8, 54, 84
24283-00	Posterman cleaner	20	29100-A1/04	PVC Poster Protectors	54, 83
24284-01	Chalk board marker (water resistant)	20	29101-0005/03	PVC Pocket 252x195 mm	85
24715-00	Cardboard clamp 20 for acrylic cover	53, 74	29101-A3/03	PVC Poster Protectors folded long side	54

INDEX OF ARTICLES

29600-0007/04	Poster Pocket 200x200 mm	89	51200-A1/91	Alu snap-type frame profile 32 mm A1 with security profile	11
29600-xx/04	Poster pocket with metal rings	72, 77	51300-A0/91	Alu snap-type frame profile 44 mm A0	11
29607-A4A5/04	Poster pocket with cross bar	71	51366-A0/91	Alu snap-type frame for windows	12
29800-A4/10	Suspension cover with holes	71, 75	51372-A0/91	Counter frame	12
29850-xx/02	Price tag pocket	78	51500-xx/91	Alu snap-type frame profile 20 mm	8
30012-A1/10/H	Chalk board A1 heat resistant	57	52100-xx/91	Alu pavement support profile 32 mm Premium	14
30012-A1/15	Chalk boards	57	52130-A1/91	Alu pavement support weather-resistant A1 PLUS	15
30302-A4/20	L-support chalkboard	78	54641-xx/T	Poster-VIP ECO A1	15
32013-00/13	Box for business cards T, Tribler	77	54651-00	Poster-Vip W A1	15
32014-00/31	Leaflet box T	76	57110-10	Key for security profile	11
32034-00/105	Leaflet box T 3-fold	77	57810-91/2000	Poster rail round tube	64
32114-00/35	Leaflet box W	77	58000-xx/91	Alu profile frame	13
33043-xx	Showcard stand N	25	58412-xx/91	Topper	13
33153-xx	Showcard stand BK	25	58525-0001/91	Alu profile U-frame	13
33263-xx	Showcard stand SK	26	59100-xx/91	LED alu snap-type frame	21
33273-xx	Showcard stand SK laminate	26	61015-00/1400/x	Leaflet dispenser QP	16
33283-xx	Showcard stand BD-Mini	27	63112-91/1600	Showcard stand Liberty with alu profile frame A2	13
33292-xx	Showcard stand BD-ECO	28	71-50000-91/xxxx	Alu snap rail 25 mm	67
33312-xx	Showcard stand BD	28	71-51401-00	Alu snap-type frame profile 32 mm mitred corners ECO	10
33342-03/00/-0620	Acrylic showcard stand BD	28	71-51501-00	Alu snap-type frame profile 32 mm chromium corners ECO	10
33353-33/-2500/33	Showcard stand Alu-BD with flag suspension	29	71-52006-A1/91	Alu pavement support profile 25 mm ECO	14
33383-10/320	Showcard stand Woodline	18	71-52116-A1/91	Alu pavement support profile 32 mm ECO	14
33383-91/-1900/10	Floor showcard stand Woodline	18	71-58401-00	Alu snap-type frame profile 25 mm ECO	9
33384-10/320	Showcard stand Woodline	18	80462-00	Container 7 L	85
33384-91/-1900/10	Floor showcard stand Woodline	18	80463-00	Container 11 L	85
33424-xx	Showcard stand L	24	84-15497-xx	End cap large for checkout divider 30x30 mm transparent	80
33504-00	Acrylic showcard stand K	27	84-15499-xx	End cap for checkout divider 30x30 mm transparent	80
33513-G-xx	Showcard stand K Greenline	27	88-37000-00/300	Checkout divider 30x30 mm transparent	80
33523-xx	Showcard stand K	23	90-39020	Pallet claw	49
33534-xx	Showcard stand K round	23	90-39041	Pallet claw weather-resistant	49
33563-xx	Showcard stand SK ECO	26	90-422206	Replacement tray for leaflet dispenser qP	16
33623-xx	Showcard stand KB	24			
33770-xx/-800	EURO pallet weather-resistant Showcard Stand	30			
33956-xx	Shopper stopper with swivel frame A6 landscape	88			
34054-xx	Showcard stand NT with chromium tube	25			
34084-xx/01	Showcard stand NT with plastic tube	24			
34224-xx/-1000	Showcard stand K ECO	22			
35424-xx	Showcard holder DK	44			
35434-xx/-500	Showcard holder DK with spring clamp	44			
35550-xx	Cardboard clamp 140 with MF connector	40			
36100-03/xxx	KL base with cardholder	22			
37010-06/310	Checkout divider 30x30 mm red	80			
37020-00	Checkout divider Wood	20, 80			
37030-00	Checkout divider T	20, 80			
38400-91/6/xxx	KL stand	22			
38410-33/1600	Gallow showcard stand Alu-BD fixed	29			
38411-33/-1900	Gallow showcard stand Alu-BD adjustable	30			
38420-33/1600	Gallow showcard stand Alu-BD fixed	29			
38421-33/-1900	Gallow showcard stand Alu-BD adjustable	30			
38790-91/1900/0550	Gallow showcard stand qP	29			
39200-xx/10	Infoline T	82			
39405-xx/10	Infoline 400A	82			
39445-xx/10	Infoline 401	82			
39630-xx/5	Infoline W A3	82			
39640-xx/10	Infoline W A4	82			
39871-xx	Posterline Stand	83			
39891-xx	Posterline Wall	83			
48100-7016/550/xxx	Hexagonal key	47			
50100-91/xxxx	Alu clamp rail 40 mm	67			
50110-91/xxxx	Alu clamp rail 40 mm with adhesive tape	67			
50301-91	Tensile frame A1	12			
50920-91/1000	Ambiente Poster Rail	60			
50920-91/R0800	Ambiente Poster Rail Bended	60			
51000-xx/91	Alu snap-type frame profile 25 mm Premium	8			
51100-xx/91	Alu snap-type frame profile 32 mm mitred corners Premium	9			
51101-xx/91	Alu snap-type frame profile 32 mm chromium corners Premium	9			
51130-A1/91	Alu snap-type frame profile 32 mm weather resistant A1 Plus	10			
51166-xx/91	Alu snap-type frame for windows	12			
51172-xx/91	Counter frame	12			

COLOUR CHART

In our extensive OEK colour range you will certainly find the “right match”. Select your desired colour and replace the suffix “xx” of the article number by the corresponding colour code ().

The following shown colours can only reflect approximately the actual colour shade of the final product due to printing techniques.

STANDARD COLOURS

-  White (01)
similar to RAL 9010, pure white

-  Grey (03)
similar to RAL 7035, light grey

-  Yellow (04)
similar to RAL 1018, zinc yellow

-  Red (06)
similar to RAL 3000, flame red

-  Green (07)
similar to RAL 6032, signal green

-  Blue (08)
similar to RAL 5015, sky blue

-  Anthracite gray (7016)
similar to RAL 7016, anthracite gray

-  Black (10)
similar to RAL 9005, jet black

ADDITIONAL COLOURS

-  Orange (05)
similar to RAL 2008, bright red orange

-  Traffic red (3020)
similar to RAL 3020, traffic red

-  Ultramarine blue (28)
similar to RAL 5002, ultramarine blue

-  Emerald green (6001)
similar to RAL 6001, emerald green

-  Traffic green (6024)
similar to RAL 6024, traffic green

SPECIAL COLOURS

-  Transparent (00)

-  Silver (30)
matt

-  Metallic silver (34)
similar to RAL 9006, white aluminium

-  Polished chromium (35)

TERMS AND CONDITIONS

The following terms and conditions apply to all contracts concluded by us, provided that our contractor is an entrepreneur. Arrangements derogating from these Terms and Conditions, in particular regulations to the contrary in other Terms and Conditions shall not become part of the contract. These Terms and Conditions also apply to all further transactions with the contractor.

1. QUOTATION AND CONTRACT CONCLUSION

Our quotations are non-binding. The contract does not come into effect until the order is delivered or confirmed in writing through us. The conclusion of the contract shall be subject to the reservation of complete and correct self-supply, insofar as sufficient hedging transactions have been settled and are necessary for contract conclusion. Price lists, catalogue and brochure images as well as technical drawings and indications concerning price, measurement and weight included therein are non-binding. We reserve the right to make changes in the technical realization of our products, if this does not considerably affect usage and appearance of the product. Color samples and specifications do in any case represent approximate values only. Also for partial deliveries we explicitly reserve the right of marginal color deviations.

2. PRICES

Unless anything else has been agreed on in writing, all prices are quoted ex works excluding packaging and VAT. A minimum order surcharge of 5,- Euro is invoiced for order values that amount to less than 50,- Euro.

3. DELIVERY

We are entitled to execute deliveries by instalments according to the production progress as far as this is reasonable for the customer. The customer is entitled to withdraw from the contract on account of a delay in delivery only after he has threatened to do so granting us adequate additional time. A delay of delivery on our part is not given if the customer is in arrears with a payment towards us which arises out of the same or another contract. For special models we are entitled to carry out deliveries that deviate in quantity up to $\pm 10\%$ of the quantity ordered, these deviations are due to production.

4. DISPATCH

Dispatch shall always be at the risk of the customer, even if postage paid delivery is agreed upon. Packing will be charged at cost price and will not be taken back.

5. TERMS OF PAYMENT

All accounts shall be paid within 30 days after the invoice date. The goods may be dispatched - at our option - cash on delivery or cash before delivery. A customer is entitled to offset against our claims only if the counterclaim is undisputed or a legally enforceable title is existent. The customer can only claim a right of retention provided that his claims arise from the same contractual relationship.

Goods delivered shall remain our property until all claims arising from the business relationship with the customer are paid in full. In the case of a current account, the property subject to reservation of title shall serve as security for our every payment balance claim.

The purchaser is only entitled to sell the products subject to reservation of title as part of proper business activities and as long as he is not in default of payment. Other actions which endanger our property are excluded. The customer assigns any receivables arising from the resale of the goods to us with immediate effect.

The customer is granted the authorization to collect the claims ceded to us; we are entitled to withdraw this authorization as well as the authorization to resell the goods subject to reservation of title if the customer does not fulfil his obligations towards us.

The customer will at any time provide us with all requested information regarding the goods subject to reservation of title or regarding the claims that hereafter have been ceded to us.

The customer shall immediately notify us of any access or claims by third parties regarding the goods subject to reservation of title and provide us with the necessary documents. The customer will also immediately notify the third party of our reservation of title. The customer shall bear the costs of a defence against such accesses and claims.

7. NOTIFICATION OF DEFECTS, WARRANTY, LIABILITY

The customer shall examine the goods for damages or material defects immediately after receiving, latest within one week after delivery. Notification of defects must be made immediately, latest within one week after discovery. If the goods are deficient or lack warranted qualities our warranty is restricted to repair or replacement at our option for the time being. Hereto the customer must grant us a reasonable period of time and opportunity. We bear the expenses necessary for the purpose of repair, provided that these are not disproportionate. Expenses that exceed the sales price are to be regarded disproportionate.

If repair or replacement is not reasonable for the customer or if the repair fails at least twice, the customer is entitled to lower the purchase price or withdraw from the contract.

Compensation claims obtain only according to the following regulations:

We do only bear liability in the case of intent or gross negligence of the company or our assistants and vicarious agents. This does not apply for the breach of fundamental contractual obligations, in particular compensation claims due to non-performance, on account of delay or in case the contract cannot be fulfilled on our part, for claims resulting from injury to life, body or health and in the case of a liability under the product liability legislation. In the event of a breach of essential contractual duties which is based on other circumstances than intent or gross negligence, liability is limited to foreseeable and typical damage.

Claims arising from material defects lapse one year after delivery of the goods.

8. DRAFTS AND SAMPLES

Our drafts and samples of all kind may neither be imitated or copied, nor made available to third parties without our prior permission in writing. In each case of culpable violation the customer is obliged to pay us a contractual penalty of 5.000 Euro which is taken into account to further compensation claims.

9. PLACE OF JURISDICTION AND PERFORMANCE

Place of performance for the consignment or service to be provided by us is Leipheim/Donau.

Place of jurisdiction is 89312 Günzburg. German law shall apply exclusively.

As of 02/2011

we.promote.selling.



Catalogue Sales Promotion | V.2 | 07/2021
© Oechsle Display-Systeme GmbH, 2021



Oechsle Display Systeme GmbH
Rudolf-Wanzl-Straße 13-15
89340 Leipheim, Germany

Phone : +49 8221 2798-0
Fax: +49 8221 2798-27

E-mail: info@oechsle.de
Web: www.oechsle.de